

# ÜRÜN KATALOĞU

## PRODUCT CATALOGUE

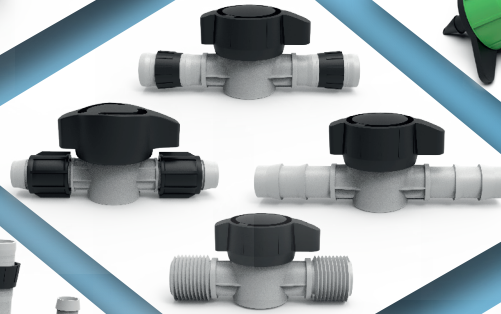
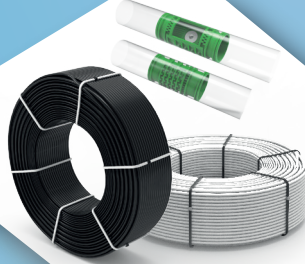

[/ www.irritime.com](http://www.irritime.com)  
[/ info@irritime.com](mailto:info@irritime.com)

**TARIMSAL SULAMA SİSTEMLERİ**  
**AGRICULTURAL IRRIGATION SYSTEMS**





DAMLA SULAMA BORUSU  
DRIP IRRIGATION PIPE .....3-23

Damla Sulama Borusu  
Drip Irrigation Pipe

DAMLAMA EK PARÇALARI  
DRIP IRRIGATION FITTINGS .....24-35

Damla Sulama Ek Parçaları  
Drip Irrigation Fittings

MİKRO YAĞMURLAMA SİSTEMLERİ  
MICRO SPRINKLER .....36-38

Mikro Yağmurlama Sistemleri  
Micro Sprinkler

PE EK PARÇALAR  
PE COMPRESSION FITTINGS .....39-44

PE Ek Parçalar  
PE Compression Fittings

FİLTRE SİSTEMLERİ  
FILTER SYSTEMS .....45-53

Filtre Sistemleri  
Filter System

PP EK PARÇALAR  
PP COMPRESSION FITTINGS .....54-68

PP Ek Parçalar  
PP Compression Fittings

YAĞMURLAMA BAŞLIKLARI  
SPRINKLERS .....69-77

Yağmurlama Sistemleri  
Sprinkler System



## STAR-R 16 MM

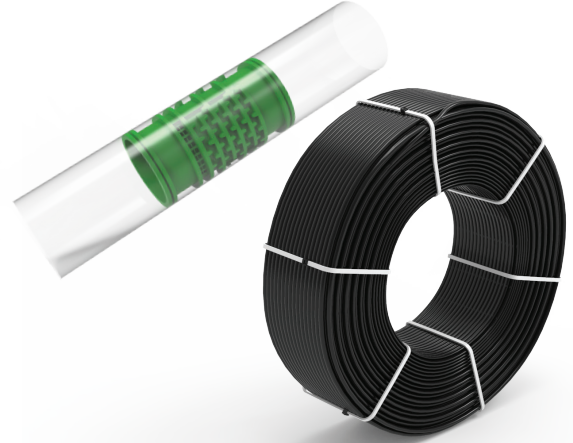

### EKO STAR 0,9 mm DAMLA SULAMA BORUSU ECO STAR 0,9 mm DRIP IRRIGATION PIPE

Çap Diameter	Et Kalınlığı Wall Thickness	Debi Flow Rate	Paketleme Packaging	Kod Code	Damlama Aralığı Distance
16 mm	0,9 mm	2,4,8 Lt/sa lph	200 or 400 metre/top meter/roll	IR160920-2	20 cm
				IR160925-2	25 cm
				IR160930-2	30 cm
				IR160933-2	33 cm
				IR160940-2	40 cm
				IR160950-2	50 cm
				IR160960-2	60 cm
				IR160975-2	75 cm
IR160910-2	100 cm				

### STAR 1,0 mm DAMLA SULAMA BORUSU STAR 1,0 mm DRIP IRRIGATION PIPE

Çap Diameter	Et Kalınlığı Wall Thickness	Debi Flow Rate	Paketleme Packaging	Kod Code	Damlama Aralığı Distance
16 mm	1,0 mm	2,4,8 Lt/sa lph	200 or 400 metre/top meter/roll	IR161020-4	20 cm
				IR161025-4	25 cm
				IR161030-4	30 cm
				IR161033-4	33 cm
				IR161040-4	40 cm
				IR161050-4	50 cm
				IR161060-4	60 cm
				IR161075-4	75 cm
IR161010-4	100 cm				

### SÜPER STAR 1,1 mm DAMLA SULAMA BORUSU SÜPER STAR 1,1 mm DRIP IRRIGATION PIPE

Çap Diameter	Et Kalınlığı Wall Thickness	Debi Flow Rate	Paketleme Packaging	Kod Code	Damlama Aralığı Distance
16 mm	1,1 mm	2,4,8 Lt/sa lph	200 or 400 metre/top meter/roll	IR161120-8	20 cm
				IR161125-8	25 cm
				IR161130-8	30 cm
				IR161133-8	33 cm
				IR161140-8	40 cm
				IR161150-8	50 cm
				IR161160-8	60 cm
				IR161175-8	75 cm
IR161110-8	100 cm				

● Please ask price for 200 mt rolls.

- Carbon Black additive Rate %2,2



# DAMLA SULAMA BORUSU DRIP IRRIGATION PIPE



## STAR-R 16 MM

Damla Sulama Borusu  
Drip Irrigation Pipe

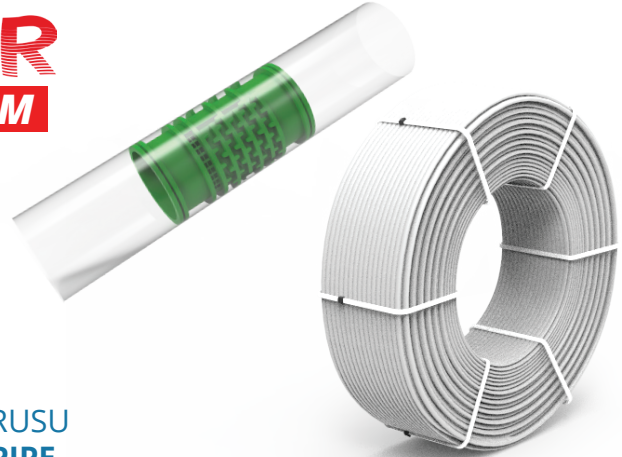
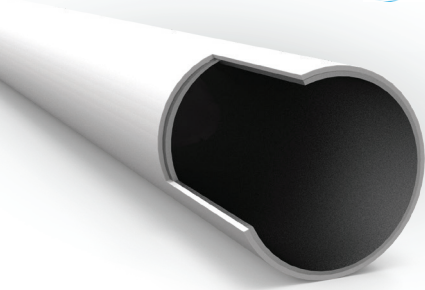

### BEYAZ EKO STAR 0,9 mm DAMLA SULAMA BORUSU WHITE ECO STAR 0,9 mm DRIP IRRIGATION PIPE

Çap Diameter	Et Kalınlığı Wall Thickness	Debi Flow Rate	Paketleme Packaging	Kod Code	Damlama Aralığı Distance
16 mm	0,9 mm	2,4,8 Lt/sa lph	200 or 400 metre/top meter/roll	IRW160920-2	20 cm
				IRW160925-2	25 cm
				IRW160930-2	30 cm
				IRW160933-2	33 cm
				IRW160940-2	40 cm
				IRW160950-2	50 cm
				IRW160960-2	60 cm
				IRW160975-2	75 cm
IRW160910-2	100 cm				

### BEYAZ STAR 1,0 mm DAMLA SULAMA BORUSU WHITE STAR 1,0 mm DRIP IRRIGATION PIPE

Çap Diameter	Et Kalınlığı Wall Thickness	Debi Flow Rate	Paketleme Packaging	Kod Code	Damlama Aralığı Distance
16 mm	1,0 mm	2,4,8 Lt/sa lph	200 or 400 metre/top meter/roll	IRW161020-4	20 cm
				IRW161025-4	25 cm
				IRW161030-4	30 cm
				IRW161033-4	33 cm
				IRW161040-4	40 cm
				IRW161050-4	50 cm
				IRW161060-4	60 cm
				IRW161075-4	75 cm
IRW161010-4	100 cm				

### BEYAZ SÜPER STAR 1,1 mm DAMLA SULAMA BORUSU WHITE SÜPER STAR 1,1 mm DRIP IRRIGATION PIPE

Çap Diameter	Et Kalınlığı Wall Thickness	Debi Flow Rate	Paketleme Packaging	Kod Code	Damlama Aralığı Distance
16 mm	1,1 mm	2,4,8 Lt/sa lph	200 or 400 metre/top meter/roll	IRW161120-8	20 cm
				IRW161125-8	25 cm
				IRW161130-8	30 cm
				IRW161133-8	33 cm
				IRW161140-8	40 cm
				IRW161150-8	50 cm
				IRW161160-8	60 cm
				IRW161175-8	75 cm
IRW161110-8	100 cm				

**Please ask price for 200 mt rolls.  
Minimum Order Quantity 20.000 meters (50 Rolls)**

- Outer Coating UV Stabilizer Additive Rate 3%
- Inner Coating Carbon Black additive Rate %2,2



## STAR-R 16 MM

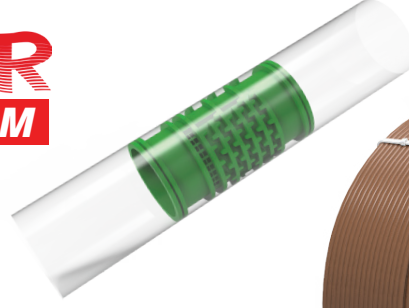
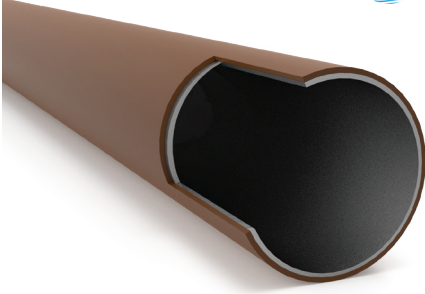

### KAHVERENGİ EKO STAR 0,9 mm DAMLA SULAMA BORUSU BROWN ECO STAR 0,9 mm DRIP IRRIGATION PIPE

Çap Diameter	Et Kalınlığı Wall Thickness	Debi Flow Rate	Paketleme Packaging	Kod Code	Damlama Aralığı Distance
16 mm	0,9 mm	2,4,8 Lt/sa lph	200 or 400 metre/top meter/roll	IRB160920-2	20 cm
				IRB160925-2	25 cm
				IRB160930-2	30 cm
				IRB160933-2	33 cm
				IRB160940-2	40 cm
				IRB160950-2	50 cm
				IRB160960-2	60 cm
				IRB160975-2	75 cm
IRB160910-2	100 cm				

### KAHVERENGİ STAR 1,0 mm DAMLA SULAMA BORUSU BROWN STAR 1,0 mm DRIP IRRIGATION PIPE

Çap Diameter	Et Kalınlığı Wall Thickness	Debi Flow Rate	Paketleme Packaging	Kod Code	Damlama Aralığı Distance
16 mm	1,0 mm	2,4,8 Lt/sa lph	200 or 400 metre/top meter/roll	IRB161020-4	20 cm
				IRB161025-4	25 cm
				IRB161030-4	30 cm
				IRB161033-4	33 cm
				IRB161040-4	40 cm
				IRB161050-4	50 cm
				IRB161060-4	60 cm
				IRB161075-4	75 cm
IRB161010-4	100 cm				

### KAHVERENGİ SÜPER STAR 1,1 mm DAMLA SULAMA BORUSU BROWN SÜPER STAR 1,1 mm DRIP IRRIGATION PIPE

Çap Diameter	Et Kalınlığı Wall Thickness	Debi Flow Rate	Paketleme Packaging	Kod Code	Damlama Aralığı Distance
16 mm	1,1 mm	2,4,8 Lt/sa lph	200 or 400 metre/top meter/roll	IRB161120-8	20 cm
				IRB161125-8	25 cm
				IRB161130-8	30 cm
				IRB161133-8	33 cm
				IRB161140-8	40 cm
				IRB161150-8	50 cm
				IRB161160-8	60 cm
				IRB161175-8	75 cm
IRB161110-8	100 cm				

**Please ask price for 200 mt rolls.  
Minimum Order Quantity 20.000 meters (50 Rolls)**

- Outer Coating UV Stabilizer Additive Rate 3%
- Inner Coating Carbon Black additive Rate %2,2



# DAMLA SULAMA BORUSU DRIP IRRIGATION PIPE



Damla Sulama Borusu  
Drip Irrigation Pipe

## STAR-R 16 MM

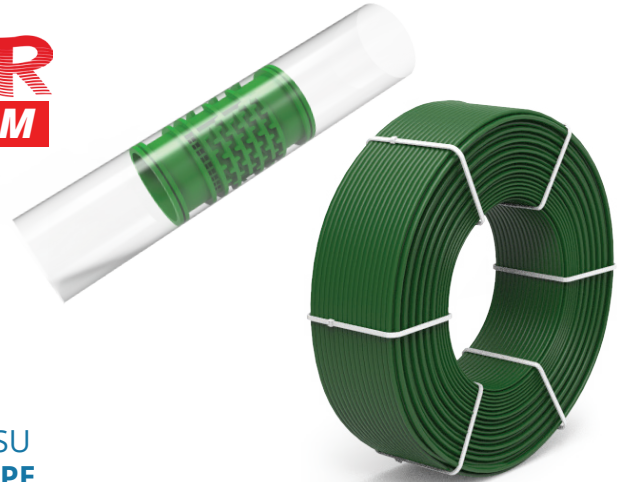
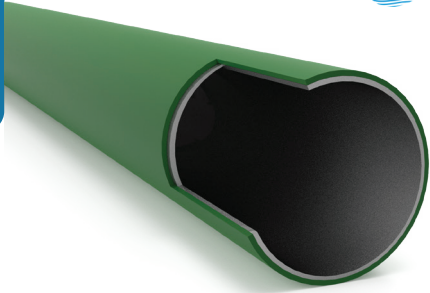

### YEŞİL EKO STAR 0,9 mm DAMLA SULAMA BORUSU GREEN ECO STAR 0,9 mm DRIP IRRIGATION PIPE

Çap Diameter	Et Kalınlığı Wall Thickness	Debi Flow Rate	Paketleme Packaging	Kod Code	Damlama Aralığı Distance
16 mm	0,9 mm	2,4,8 Lt/sa lph	200 or 400 metre/top meter/roll	IRG160920-2	20 cm
				IRG160925-2	25 cm
				IRG160930-2	30 cm
				IRG160933-2	33 cm
				IRG160940-2	40 cm
				IRG160950-2	50 cm
				IRG160960-2	60 cm
				IRG160975-2	75 cm
IRG160910-2	100 cm				

### YEŞİL STAR 1,0 mm DAMLA SULAMA BORUSU GREEN STAR 1,0 mm DRIP IRRIGATION PIPE

Çap Diameter	Et Kalınlığı Wall Thickness	Debi Flow Rate	Paketleme Packaging	Kod Code	Damlama Aralığı Distance
16 mm	1,0 mm	2,4,8 Lt/sa lph	200 or 400 metre/top meter/roll	IRG161020-4	20 cm
				IRG161025-4	25 cm
				IRG161030-4	30 cm
				IRG161033-4	33 cm
				IRG161040-4	40 cm
				IRG161050-4	50 cm
				IRG161060-4	60 cm
				IRG161075-4	75 cm
IRG161010-4	100 cm				

### YEŞİL SÜPER STAR 1,1 mm DAMLA SULAMA BORUSU GREEN SÜPER STAR 1,1 mm DRIP IRRIGATION PIPE

Çap Diameter	Et Kalınlığı Wall Thickness	Debi Flow Rate	Paketleme Packaging	Kod Code	Damlama Aralığı Distance
16 mm	1,1 mm	2,4,8 Lt/sa lph	200 or 400 metre/top meter/roll	IRG161120-8	20 cm
				IRG161125-8	25 cm
				IRG161130-8	30 cm
				IRG161133-8	33 cm
				IRG161140-8	40 cm
				IRG161150-8	50 cm
				IRG161160-8	60 cm
				IRG161175-8	75 cm
IRG161110-8	100 cm				

**Please ask price for 200 mt rolls.**

**Minimum Order Quantity 20.000 meters (50 Rolls)**

- Outer Coating UV Stabilizer Additive Rate 3%
- Inner Coating Carbon Black additive Rate %2,2





## STAR-R 16 MM

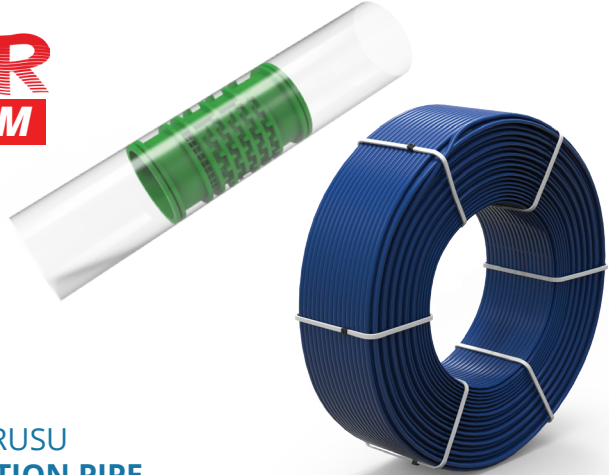
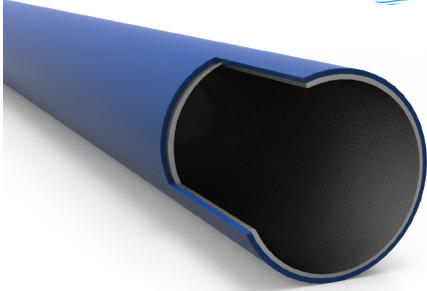

### MAVİ EKO STAR 0,9 mm DAMLA SULAMA BORUSU DARK BLUE ECO STAR 0,9 mm DRIP IRRIGATION PIPE

Çap Diameter	Et Kalınlığı Wall Thickness	Debi Flow Rate	Paketleme Packaging	Kod Code	Damlama Aralığı Distance
16 mm	0,9 mm	2,4,8 Lt/sa lph	200 or 400 metre/top meter/roll	IRD160920-2	20 cm
				IRD160925-2	25 cm
				IRD160930-2	30 cm
				IRD160933-2	33 cm
				IRD160940-2	40 cm
				IRD160950-2	50 cm
				IRD160960-2	60 cm
				IRD160975-2	75 cm
IRD160910-2	100 cm				

### MAVİ STAR 1,0 mm DAMLA SULAMA BORUSU DARK BLUE STAR 1,0 mm DRIP IRRIGATION PIPE

Çap Diameter	Et Kalınlığı Wall Thickness	Debi Flow Rate	Paketleme Packaging	Kod Code	Damlama Aralığı Distance
16 mm	1,0 mm	2,4,8 Lt/sa lph	200 or 400 metre/top meter/roll	IRD161020-4	20 cm
				IRD161025-4	25 cm
				IRD161030-4	30 cm
				IRD161033-4	33 cm
				IRD161040-4	40 cm
				IRD161050-4	50 cm
				IRD161060-4	60 cm
				IRD161075-4	75 cm
IRD161010-4	100 cm				

### MAVİ SÜPER STAR 1,1 mm DAMLA SULAMA BORUSU DARK BLUE SÜPER STAR 1,1 mm DRIP IRRIGATION PIPE

Çap Diameter	Et Kalınlığı Wall Thickness	Debi Flow Rate	Paketleme Packaging	Kod Code	Damlama Aralığı Distance
16 mm	1,1 mm	2,4,8 Lt/sa lph	200 or 400 metre/top meter/roll	IRD161120-8	20 cm
				IRD161125-8	25 cm
				IRD161130-8	30 cm
				IRD161133-8	33 cm
				IRD161140-8	40 cm
				IRD161150-8	50 cm
				IRD161160-8	60 cm
				IRD161175-8	75 cm
IRD161110-8	100 cm				

**Please ask price for 200 mt rolls.**

**Minimum Order Quantity 20.000 meters (50 Rolls)**

- Outer Coating UV Stabilizer Additive Rate 3%
- Inner Coating Carbon Black additive Rate %2,2



# DAMLA SULAMA BORUSU DRIP IRRIGATION PIPE



Damla Sulama Borusu  
Drip Irrigation Pipe

## KÖR BORU (DÜZ BORU) BLIND HOSE (PLAIN PIPE)

# STAR-R

**16 MM**

Kod Code	Çap Ø Diameter	Et Kalınlığı Wall Thickness	Rulo Uzunluğu Roll Length
IR1609	16 mm	0,9 mm	200 or 400 metre/top meter/roll
IR1610		1,0 mm	
IR1611		1,1 mm	
IR1612		1,2 mm	

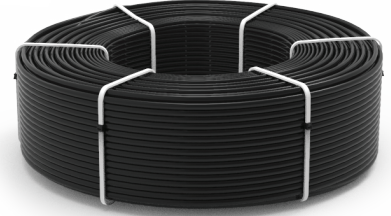

Kod Code	Çap Ø Diameter	Et Kalınlığı Wall Thickness	Rulo Uzunluğu Roll Length
IRW1609	16 mm	0,9 mm	200 or 400 metre/top meter/roll
IRW1610		1,0 mm	
IRW1611		1,1 mm	
IRW1612		1,2 mm	

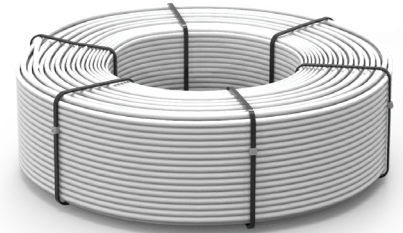

Kod Code	Çap Ø Diameter	Et Kalınlığı Wall Thickness	Rulo Uzunluğu Roll Length
IRB1609	16 mm	0,9 mm	200 or 400 metre/top meter/roll
IRB1610		1,0 mm	
IRB1611		1,1 mm	
IRB1612		1,2 mm	

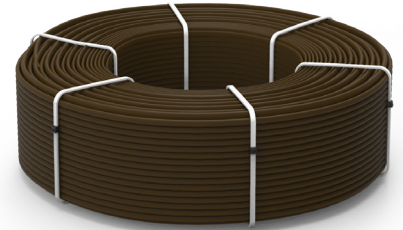

Kod Code	Çap Ø Diameter	Et Kalınlığı Wall Thickness	Rulo Uzunluğu Roll Length
IRG1609	16 mm	0,9 mm	200 or 400 metre/top meter/roll
IRG1610		1,0 mm	
IRG1611		1,1 mm	
IRG1612		1,2 mm	

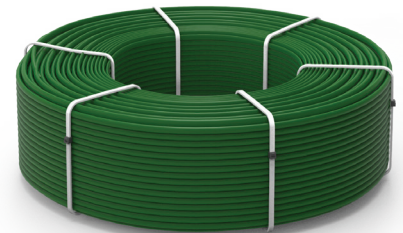

Kod Code	Çap Ø Diameter	Et Kalınlığı Wall Thickness	Rulo Uzunluğu Roll Length
IRD1609	16 mm	0,9 mm	200 or 400 metre/top meter/roll
IRD1610		1,0 mm	
IRD1611		1,1 mm	
IRD1612		1,2 mm	

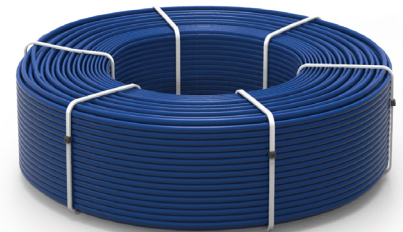

**Please ask price for 200 mt rolls.  
Minimum Order Quantity 20.000 meters (50 Rolls)**

- Outer Coating UV Stabilizer Additive Rate 3%
- Inner Coating Carbon Black additive Rate %2,2







# STAR-R 16 MM

## 16 MM PIPES LOADING PLANS

### 20" DC CONTAINER

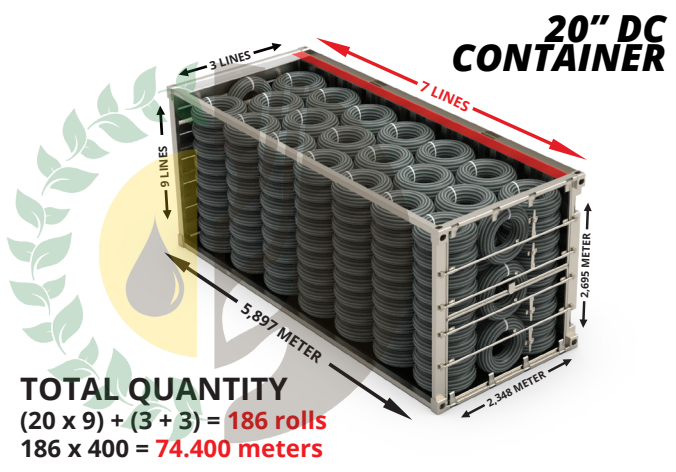

**TOTAL QUANTITY**  
 $(20 \times 9) + (3 + 3) = 186$  rolls  
 $186 \times 400 = 74.400$  meters

**5 BOXES**  
 100 boxes can fit in 20" DC Container.

**7 ROLLS STAR-T**  
 IRRITIME STAR-T Pipe  
 Midi Type Rolls  
 Mini Type Rolls  
 140 rolls can fit in 20" DC Container.

### 40" HC CONTAINER

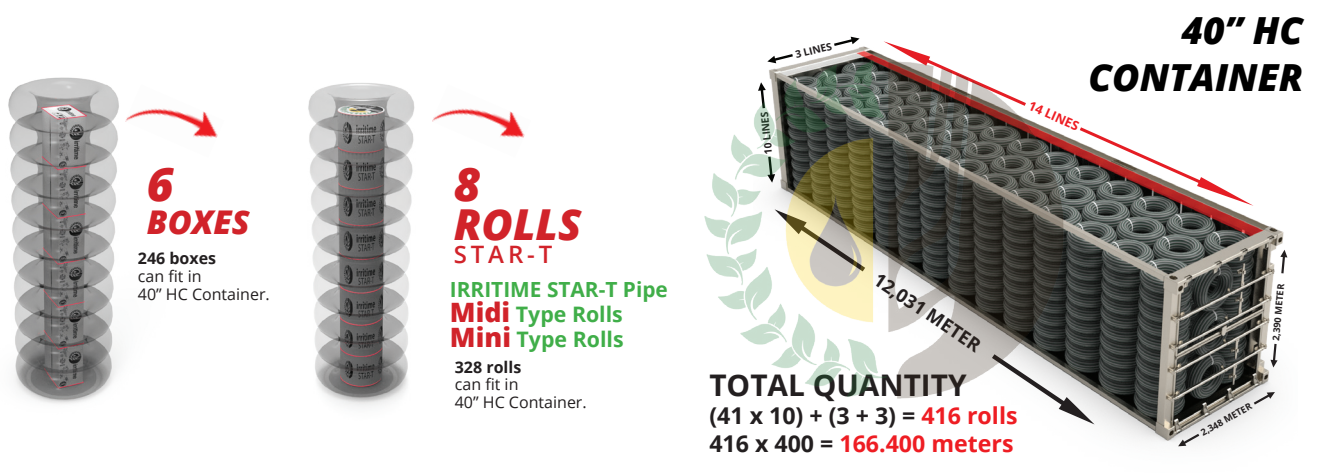

**TOTAL QUANTITY**  
 $(41 \times 10) + (3 + 3) = 416$  rolls  
 $416 \times 400 = 166.400$  meters

**6 BOXES**  
 246 boxes can fit in 40" HC Container.

**8 ROLLS STAR-T**  
 IRRITIME STAR-T Pipe  
 Midi Type Rolls  
 Mini Type Rolls  
 328 rolls can fit in 40" HC Container.

### TRUCK



**TOTAL QUANTITY**  
 $48 \times 10 = 480$  rolls  
 $480 \times 400 = 192.000$  meters

**6 BOXES**  
 288 boxes can fit in Truck

**9 ROLLS STAR-T**  
 IRRITIME STAR-T Pipe  
 Midi Type Rolls  
 Mini Type Rolls  
 432 rolls can fit in Truck



# DAMLA SULAMA BORUSU DRIP IRRIGATION PIPE



Damla Sulama Borusu  
Drip Irrigation Pipe

## STAR-R 20 MM



### STAR 20 mm DAMLA SULAMA BORUSU STAR 20 mm DRIP IRRIGATION PIPE

Çap Diameter	Et Kalınlığı Wall Thickness	Debi Flow Rate	Paketleme Packaging	Kod Code	Damlama Aralığı Distance
20 mm	1,0 mm	2,4 Lt/sa lph	300 metre/top meter/roll	IR201020-2	20 cm
				IR201025-2	25 cm
				IR201030-2	30 cm
				IR201033-2	33 cm
				IR201040-2	40 cm
				IR201050-2	50 cm
				IR201060-2	60 cm
				IR201075-2	75 cm
IR201010-2	100 cm				

### SÜPER STAR 1,1 mm DAMLA SULAMA BORUSU SÜPER STAR 1,1 mm DRIP IRRIGATION PIPE

Çap Diameter	Et Kalınlığı Wall Thickness	Debi Flow Rate	Paketleme Packaging	Kod Code	Damlama Aralığı Distance
20 mm	1,1 mm	2,4 Lt/sa lph	300 metre/top meter/roll	IR201120-4	20 cm
				IR201125-4	25 cm
				IR201130-4	30 cm
				IR201133-4	33 cm
				IR201140-4	40 cm
				IR201150-4	50 cm
				IR201160-4	60 cm
				IR201175-4	75 cm
IR201110-4	100 cm				

- Carbon Black Additive Rate %2,2



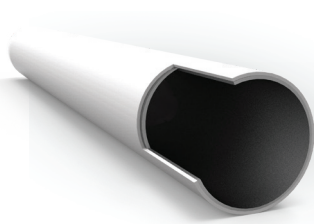

**STAR-R**  
**20 MM**

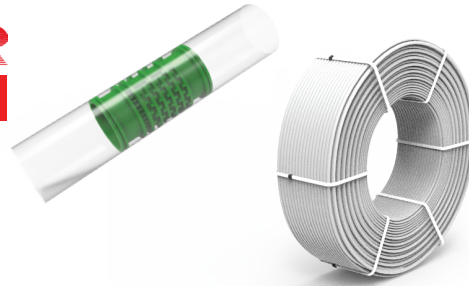

## BEYAZ STAR 20 mm DAMLA SULAMA BORUSU WHITE STAR 20 mm DRIP IRRIGATION PIPE

Çap Diameter	Et Kalınlığı Wall Thickness	Debi Flow Rate	Paketleme Packaging	Kod Code	Damlama Aralığı Distance
20 mm	1,0 mm	2,4 Lt/sa lph	300 metre/top meter/roll	IRW201020-2	20 cm
				IRW201025-2	25 cm
				IRW201030-2	30 cm
				IRW201033-2	33 cm
				IRW201040-2	40 cm
				IRW201050-2	50 cm
				IRW201060-2	60 cm
				IRW201075-2	75 cm
IRW201010-2	100 cm				

## BEYAZ SÜPER STAR 20 mm DAMLA SULAMA BORUSU WHITE SÜPER STAR 20 mm DRIP IRRIGATION PIPE

Çap Diameter	Et Kalınlığı Wall Thickness	Debi Flow Rate	Paketleme Packaging	Kod Code	Damlama Aralığı Distance
20 mm	1,1 mm	2,4 Lt/sa lph	300 metre/top meter/roll	IRW201120-4	20 cm
				IRW201125-4	25 cm
				IRW201130-4	30 cm
				IRW201133-4	33 cm
				IRW201140-4	40 cm
				IRW201150-4	50 cm
				IRW201160-4	60 cm
				IRW201175-4	75 cm
IRW201110-4	100 cm				

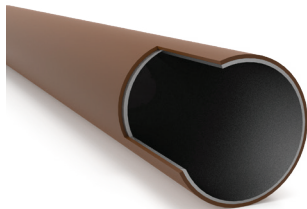

**STAR-R**  
**20 MM**

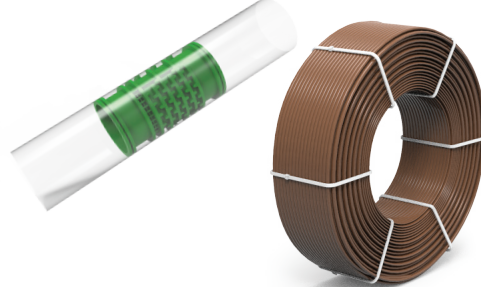

## KAHVERENGİ STAR 1,0 mm DAMLA SULAMA BORUSU BROWN STAR 1,0 mm DRIP IRRIGATION PIPE

Çap Diameter	Et Kalınlığı Wall Thickness	Debi Flow Rate	Paketleme Packaging	Kod Code	Damlama Aralığı Distance
20 mm	1,0 mm	2,4 Lt/sa lph	300 metre/top meter/roll	IRB201020-4	20 cm
				IRB201025-4	25 cm
				IRB201030-4	30 cm
				IRB201033-4	33 cm
				IRB201040-4	40 cm
				IRB201050-4	50 cm
				IRB201060-4	60 cm
				IRB201075-4	75 cm
IRB201010-4	100 cm				

## KAHVERENGİ SÜPER STAR 1,1 mm DAMLA SULAMA BORUSU BROWN SÜPER STAR 1,1 mm DRIP IRRIGATION PIPE

Çap Diameter	Et Kalınlığı Wall Thickness	Debi Flow Rate	Paketleme Packaging	Kod Code	Damlama Aralığı Distance
20 mm	1,1 mm	2,4 Lt/sa lph	300 metre/top meter/roll	IRB201120-8	20 cm
				IRB201125-8	25 cm
				IRB201130-8	30 cm
				IRB201133-8	33 cm
				IRB201140-8	40 cm
				IRB201150-8	50 cm
				IRB201160-8	60 cm
				IRB201175-8	75 cm
IRB201110-8	100 cm				

### Minimum Order Quantity 15.000 meters (50 Rolls)

- Outer Coating UV Stabilizer Additive Rate 3%
- Inner Coating Carbon Black additive Rate %2,2



# DAMLA SULAMA BORUSU DRIP IRRIGATION PIPE



Damla Sulama Borusu  
Drip Irrigation Pipe

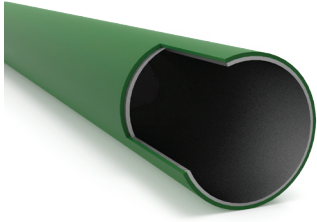

**STAR-R**  
**20 MM**

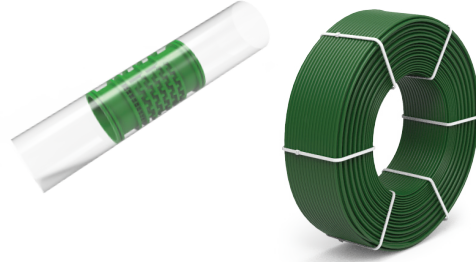

## YEŞİL STAR 1,0 mm DAMLA SULAMA BORUSU GREEN STAR 1,0 mm DRIP IRRIGATION PIPE

Çap Diameter	Et Kalınlığı Wall Thickness	Debi Flow Rate	Paketleme Packaging	Kod Code	Damlama Aralığı Distance
20 mm	1,0 mm	2,4 Lt/sa lph	300 metre/top meter/roll	IRG201020-2	20 cm
				IRG201025-2	25 cm
				IRG201030-2	30 cm
				IRG201033-2	33 cm
				IRG201040-2	40 cm
				IRG201050-2	50 cm
				IRG201060-2	60 cm
				IRG201075-2	75 cm
				IRG201010-2	100 cm

## YEŞİL SÜPER STAR 1,1 mm DAMLA SULAMA BORUSU GREEN SÜPER STAR 1,1 mm DRIP IRRIGATION PIPE

Çap Diameter	Et Kalınlığı Wall Thickness	Debi Flow Rate	Paketleme Packaging	Kod Code	Damlama Aralığı Distance
20 mm	1,1 mm	2,4 Lt/sa lph	300 metre/top meter/roll	IRG201120-4	20 cm
				IRG201125-4	25 cm
				IRG201130-4	30 cm
				IRG201133-4	33 cm
				IRG201140-4	40 cm
				IRG201150-4	50 cm
				IRG201160-4	60 cm
				IRG201175-4	75 cm
				IRG201110-4	100 cm

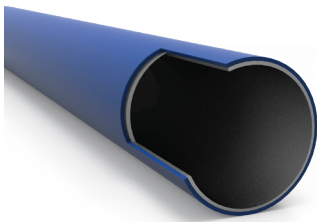

**STAR-R**  
**20 MM**

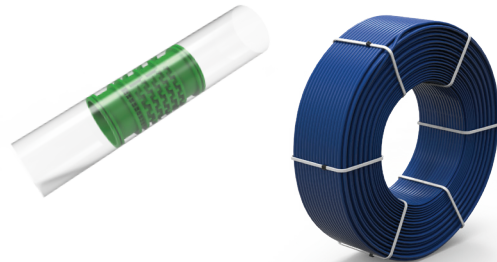

## MAVİ STAR 1,0 mm DAMLA SULAMA BORUSU DARK BLUE STAR 1,0 mm DRIP IRRIGATION PIPE

Çap Diameter	Et Kalınlığı Wall Thickness	Debi Flow Rate	Paketleme Packaging	Kod Code	Damlama Aralığı Distance
20 mm	1,0 mm	2,4 Lt/sa lph	300 metre/top meter/roll	IRD201020-2	20 cm
				IRD201025-2	25 cm
				IRD201030-2	30 cm
				IRD201033-2	33 cm
				IRD201040-2	40 cm
				IRD201050-2	50 cm
				IRD201060-2	60 cm
				IRD201075-2	75 cm
				IRD161010-2	100 cm

## MAVİ SÜPER STAR 1,1 mm DAMLA SULAMA BORUSU DARK BLUE SÜPER STAR 1,1 mm DRIP IRRIGATION PIPE

Çap Diameter	Et Kalınlığı Wall Thickness	Debi Flow Rate	Paketleme Packaging	Kod Code	Damlama Aralığı Distance
20 mm	1,1 mm	2,4 Lt/sa lph	300 metre/top meter/roll	IRD201120-4	20 cm
				IRD201125-4	25 cm
				IRD201130-4	30 cm
				IRD201133-4	33 cm
				IRD201140-4	40 cm
				IRD201150-4	50 cm
				IRD201160-4	60 cm
				IRD201175-4	75 cm
				IRD201110-4	100 cm

**Minimum Order Quantity 15.000 meters (50 Rolls)**

- Outer Coating UV Stabilizer Additive Rate 3%
- Inner Coating Carbon Black additive Rate %2,2



## KÖR BORU (DÜZ BORU) BLIND HOSE (PLAIN PIPE)

# STAR-R

**20 MM**

Damla Sulama Borusu  
Drip Irrigation Pipe

Kod Code	Çap Ø Diameter	Et Kalınlığı Wall Thickness	Rulo Uzunluğu Roll Length
IR2010	20 mm	1,0 mm	300 metre/top meter/roll
IR2011		1,1 mm	
IR2012		1,2 mm	

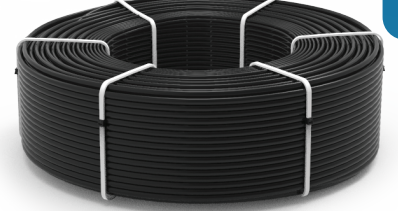

Kod Code	Çap Ø Diameter	Et Kalınlığı Wall Thickness	Rulo Uzunluğu Roll Length
IRW2010	20 mm	1,0 mm	300 metre/top meter/roll
IRW2011		1,1 mm	
IRW2012		1,2 mm	

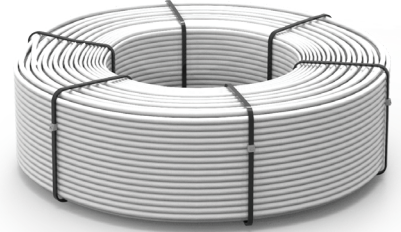

Kod Code	Çap Ø Diameter	Et Kalınlığı Wall Thickness	Rulo Uzunluğu Roll Length
IRB2010	20 mm	1,0 mm	300 metre/top meter/roll
IRB2011		1,1 mm	
IRB2012		1,2 mm	

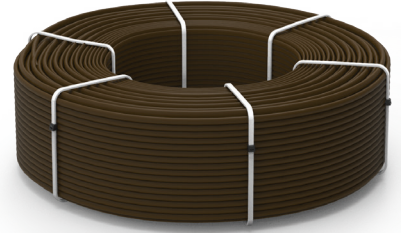

Kod Code	Çap Ø Diameter	Et Kalınlığı Wall Thickness	Rulo Uzunluğu Roll Length
IRG2010	20 mm	1,0 mm	300 metre/top meter/roll
IRG2011		1,1 mm	
IRG2012		1,2 mm	

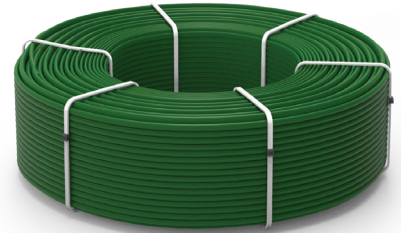

Kod Code	Çap Ø Diameter	Et Kalınlığı Wall Thickness	Rulo Uzunluğu Roll Length
IRD2010	20 mm	1,0 mm	300 metre/top meter/roll
IRD2011		1,1 mm	
IRD2012		1,2 mm	



**Minimum Order Quantity 15.000 meters (50 Rolls)**

- Outer Coating UV Stabilizer Additive Rate 3%
- Inner Coating Carbon Black additive Rate %2,2



## STAR-R 20 MM

### 20 MM PIPES LOADING PLANS

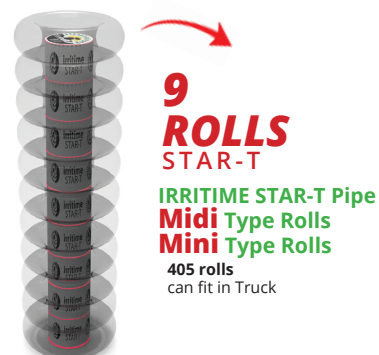
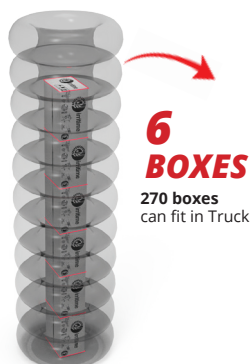
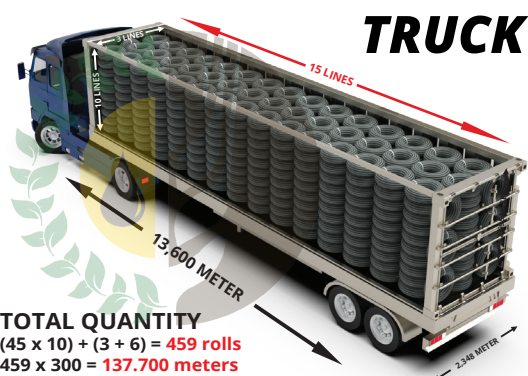
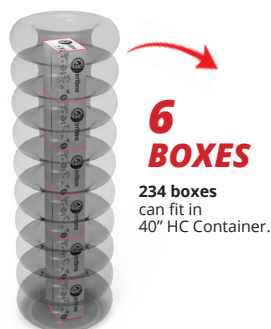
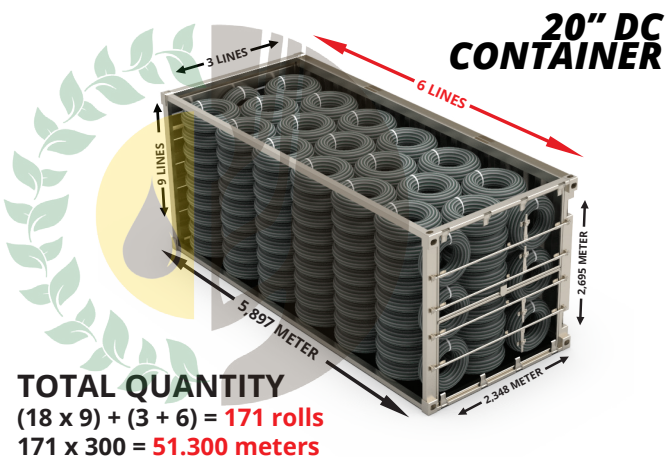



## STAR-P 16 MM

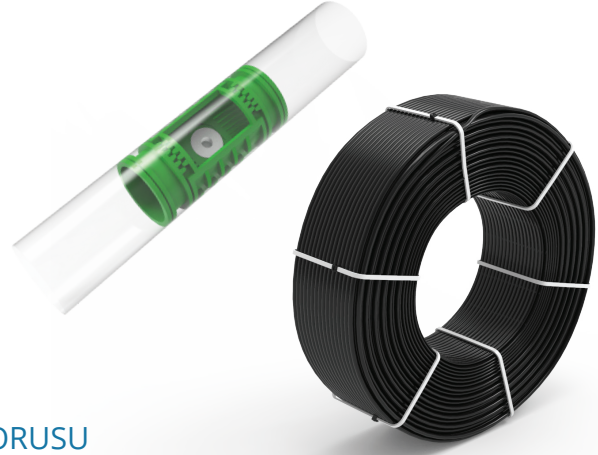

### STAR 16 mm BASINÇ AYARLI DAMLA SULAMA BORUSU STAR 16 mm PC DRIPLINE

Çap Diameter	Et Kalınlığı Wall Thickness	Debi Flow Rate	Paketleme Packaging	Kod Code	Damlama Aralığı Distance
16 mm	0,9 mm	1,6 2,0 4,0 Lt/sa lph	200 or 400 metre/top meter/roll	IPC160920-1,6	20 cm
				IPC160925-1,6	25 cm
				IPC160930-1,6	30 cm
				IPC160933-1,6	33 cm
				IPC160940-1,6	40 cm
				IPC160950-1,6	50 cm
				IPC160960-1,6	60 cm
				IPC160975-1,6	75 cm
IPC160910-1,6	100 cm				

### STAR 16 mm BASINÇ AYARLI DAMLA SULAMA BORUSU STAR 16 mm PC DRIPLINE

Çap Diameter	Et Kalınlığı Wall Thickness	Debi Flow Rate	Paketleme Packaging	Kod Code	Damlama Aralığı Distance
16 mm	1,0 mm	1,6 2,0 4,0 Lt/sa lph	200 or 400 metre/top meter/roll	IPC161020-2	20 cm
				IPC161025-2	25 cm
				IPC161030-2	30 cm
				IPC161033-2	33 cm
				IPC161040-2	40 cm
				IPC161050-2	50 cm
				IPC161060-2	60 cm
				IPC161075-2	75 cm
IPC161010-2	100 cm				

### STAR 20 mm BASINÇ AYARLI DAMLA SULAMA BORUSU STAR 20 mm PC DRIPLINE

Çap Diameter	Et Kalınlığı Wall Thickness	Debi Flow Rate	Paketleme Packaging	Kod Code	Damlama Aralığı Distance
20 mm	1,0 mm	2,0 4,0 Lt/sa lph	300 metre/top meter/roll	IPC201020-4	20 cm
				IPC201025-4	25 cm
				IPC201030-4	30 cm
				IPC201033-4	33 cm
				IPC201040-4	40 cm
				IPC201050-4	50 cm
				IPC201060-4	60 cm
				IPC201075-4	75 cm
IPC201010-4	100 cm				

● Please ask price for 200 mt rolls.

- Carbon Black additive Rate %2,2



# DAMLA SULAMA BORUSU DRIP IRRIGATION PIPE



Damla Sulama Borusu  
Drip Irrigation Pipe



## STAR-T mini

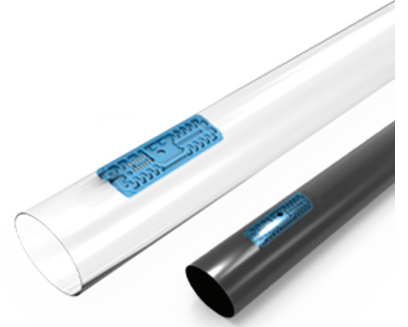

### MİNİ STAR DAMLA SULAMA BORUSU 6 MİL MINI STAR T-TAPE DRIP PIPE 6 MIL

Çap Diameter	Et Kalınlığı Wall Thickness	Debi Flow Rate	Paketleme Packaging	Kod Code	Damlama Aralığı Distance
16 mm	6 mil (0,15mm)	1,0 1,6 2,2 3,5 Lt/h	500 metre/top meter/roll	IRN171510-1	10 cm
				IRN171515-1	15 cm
				IRN171520-1	20 cm
				IRN171525-1	25 cm
				IRN171530-1	30 cm
				IRN171533-1	33 cm
				IRN171540-1	40 cm
				IRN171550-1	50 cm
IRN171560-1	60 cm				

### MİNİ STAR DAMLA SULAMA BORUSU 8 MİL MINI STAR T-TAPE DRIP PIPE 8 MIL

Çap Diameter	Et Kalınlığı Wall Thickness	Debi Flow Rate	Paketleme Packaging	Kod Code	Damlama Aralığı Distance
16 mm	8 mil (0,20mm)	1,0 1,6 2,2 3,5 Lt/h	500 metre/top meter/roll	IRN172010-1	10 cm
				IRN172015-1	15 cm
				IRN172020-1	20 cm
				IRN172025-1	25 cm
				IRN172030-1	30 cm
				IRN172033-1	33 cm
				IRN172040-1	40 cm
				IRN172050-1	50 cm
IRN172060-1	60 cm				

### MİNİ STAR DAMLA SULAMA BORUSU 10 MİL MINI STAR T-TAPE DRIP PIPE 10 MIL

Çap Diameter	Et Kalınlığı Wall Thickness	Debi Flow Rate	Paketleme Packaging	Kod Code	Damlama Aralığı Distance
16 mm	10 mil (0,25mm)	1,0 1,6 2,2 3,5 Lt/h	400 metre/top meter/roll	IRN172510-1	10 cm
				IRN172515-1	15 cm
				IRN172520-1	20 cm
				IRN172525-1	25 cm
				IRN172530-1	30 cm
				IRN172533-1	33 cm
				IRN172540-1	40 cm
				IRN172550-1	50 cm
IRN172560-1	60 cm				





## STAR-T mini

Damla Sulama Borusu  
Drip Irrigation Pipe

### MİNİ STAR DAMLA SULAMA BORUSU 12 MİL MINI STAR T-TAPE DRIP PIPE 12 MIL

Çap Diameter	Et Kalınlığı Wall Thickness	Debi Flow Rate	Paketleme Packaging	Kod Code	Damlama Aralığı Distance
16 mm	12 mil (0,30 mm)	1,0 1,6 2,2 3,5 Lt/h	350 metre/top meter/roll	IRN173010-1	10 cm
				IRN173015-1	15 cm
				IRN173020-1	20 cm
				IRN173025-1	30 cm
				IRN173030-1	30 cm
				IRN173033-1	33 cm
				IRN173040-1	40 cm
				IRN173050-1	50 cm
IRN173060-1	60 cm				

### MİNİ STAR DAMLA SULAMA BORUSU 16 MİL MINI STAR T-TAPE DRIP PIPE 16 MIL

Çap Diameter	Et Kalınlığı Wall Thickness	Debi Flow Rate	Paketleme Packaging	Kod Code	Damlama Aralığı Distance
16 mm	16 mil (0,40 mm)	1,0 1,6 2,2 3,5 Lt/h	300 metre/top meter/roll	IRN174010-1	10 cm
				IRN174015-1	15 cm
				IRN174020-1	20 cm
				IRN174025-1	30 cm
				IRN174030-1	30 cm
				IRN174033-1	33 cm
				IRN174040-1	40 cm
				IRN174050-1	50 cm
IRN174060-1	60 cm				

#### PALLET LOADING PLAN





# DAMLA SULAMA BORUSU DRIP IRRIGATION PIPE



Damla Sulama Borusu  
Drip Irrigation Pipe



## STAR-T MIDI

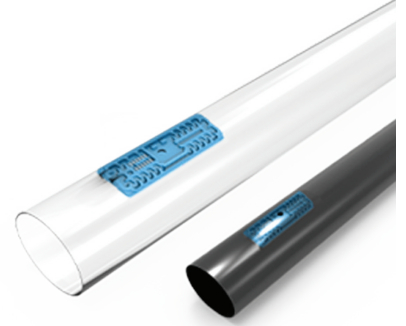

### MİDİ STAR DAMLA SULAMA BORUSU 6 MİL MIDI STAR T-TAPE DRIP PIPE 6 MIL

Çap Diameter	Et Kalınlığı Wall Thickness	Debi Flow Rate	Paketleme Packaging	Kod Code	Damlama Aralığı Distance
16 mm	6 mil (0,15mm)	1,0 1,6 2,2 3,5 Lt/h	1.000 metre/top meter/roll	IRD171510-1	10 cm
				IRD171515-1	15 cm
				IRD171520-1	20 cm
				IRD171525-1	25 cm
				IRD171530-1	30 cm
				IRD171533-1	33 cm
				IRD171540-1	40 cm
				IRD171550-1	50 cm
IRD171560-1	60 cm				

### MİDİ STAR DAMLA SULAMA BORUSU 8 MİL MIDI STAR T-TAPE DRIP PIPE 8 MIL

Çap Diameter	Et Kalınlığı Wall Thickness	Debi Flow Rate	Paketleme Packaging	Kod Code	Damlama Aralığı Distance
16 mm	8 mil (0,20mm)	1,0 1,6 2,2 3,5 Lt/h	1.000 metre/top meter/roll	IRD172010-1	10 cm
				IRD172015-1	15 cm
				IRD172020-1	20 cm
				IRD172025-1	25 cm
				IRD172030-1	30 cm
				IRD172033-1	33 cm
				IRD172040-1	40 cm
				IRD172050-1	50 cm
IRD172060-1	60 cm				

### MİDİ STAR DAMLA SULAMA BORUSU 10 MİL MIDI STAR T-TAPE DRIP PIPE 10 MIL

Çap Diameter	Et Kalınlığı Wall Thickness	Debi Flow Rate	Paketleme Packaging	Kod Code	Damlama Aralığı Distance
16 mm	10 mil (0,25mm)	1,0 1,6 2,2 3,5 Lt/h	800 metre/top meter/roll	IRD172510-1	10 cm
				IRD172515-1	15 cm
				IRD172520-1	20 cm
				IRD172525-1	25 cm
				IRD172530-1	30 cm
				IRD172533-1	33 cm
				IRD172540-1	40 cm
				IRD172550-1	50 cm
IRD172560-1	60 cm				





## STAR-T MIDI

Damla Sulama Borusu  
Drip Irrigation Pipe

### MİDİ STAR DAMLA SULAMA BORUSU 12 MİL MIDI STAR T-TAPE DRIP PIPE 12 MIL

Çap Diameter	Et Kalınlığı Wall Thickness	Debi Flow Rate	Paketleme Packaging	Kod Code	Damlama Aralığı Distance
16 mm	12 mil (0,30 mm)	1,0 1,6 2,2 3,5 Lt/h	700 metre/top meter/roll	IRD173010-1	10 cm
				IRD173015-1	15 cm
				IRD173020-1	20 cm
				IRD173025-1	25 cm
				IRD173030-1	30 cm
				IRD173033-1	33 cm
				IRD173040-1	40 cm
				IRD173050-1	50 cm
				IRD173060-1	60 cm

### MİDİ STAR DAMLA SULAMA BORUSU 16 MİL MIDI STAR T-TAPE DRIP PIPE 16 MIL

Çap Diameter	Et Kalınlığı Wall Thickness	Debi Flow Rate	Paketleme Packaging	Kod Code	Damlama Aralığı Distance
16 mm	16 mil (0,40 mm)	1,0 1,6 2,2 3,5 Lt/h	600 metre/top meter/roll	IRD174010-1	10 cm
				IRD174015-1	15 cm
				IRD174020-1	20 cm
				IRD174025-1	25 cm
				IRD174030-1	30 cm
				IRD174033-1	33 cm
				IRD174040-1	40 cm
				IRD174050-1	50 cm
				IRD174060-1	60 cm

#### PALLET LOADING PLAN





# DAMLA SULAMA BORUSU DRIP IRRIGATION PIPE



Damla Sulama Borusu  
Drip Irrigation Pipe



## STAR-T MAXI

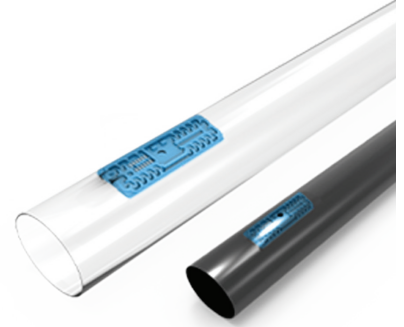

### MAXİ STAR DAMLA SULAMA BORUSU 6 MİL MAXI STAR T-TAPE DRIP PIPE 6 MIL

Çap Diameter	Et Kalınlığı Wall Thickness	Debi Flow Rate	Paketleme Packaging	Kod Code	Damlama Aralığı Distance
16 mm	6 mil (0,15mm)	1,0 1,6 2,2 3,5 Lt/h	2.500 metre/top meter/roll	IRX171510-1	10 cm
				IRX171515-1	15 cm
				IRX171520-1	20 cm
				IRX171525-1	25 cm
				IRX171530-1	30 cm
				IRX171533-1	33 cm
				IRX171540-1	40 cm
				IRX171550-1	50 cm
IRX171560-1	60 cm				

### MAXİ STAR DAMLA SULAMA BORUSU 8 MİL MAXI STAR T-TAPE DRIP PIPE 8 MIL

Çap Diameter	Et Kalınlığı Wall Thickness	Debi Flow Rate	Paketleme Packaging	Kod Code	Damlama Aralığı Distance
16 mm	8 mil (0,20mm)	1,0 1,6 2,2 3,5 Lt/h	2.300 metre/top meter/roll	IRX172010-1	10 cm
				IRX172015-1	15 cm
				IRX172020-1	20 cm
				IRX172025-1	25 cm
				IRX172030-1	30 cm
				IRX172033-1	33 cm
				IRX172040-1	40 cm
				IRX172050-1	50 cm
IRX172060-1	60 cm				

### MAXİ STAR DAMLA SULAMA BORUSU 10 MİL MAXI STAR T-TAPE DRIP PIPE 10 MIL

Çap Diameter	Et Kalınlığı Wall Thickness	Debi Flow Rate	Paketleme Packaging	Kod Code	Damlama Aralığı Distance
16 mm	10 mil (0,25mm)	1,0 1,6 2,2 3,5 Lt/h	2.000 metre/top meter/roll	IRX172510-1	10 cm
				IRX172515-1	15 cm
				IRX172520-1	20 cm
				IRX172525-1	25 cm
				IRX172530-1	30 cm
				IRX172533-1	33 cm
				IRX172540-1	40 cm
				IRX172550-1	50 cm
IRX172560-1	60 cm				





## STAR-T

### MAXI

#### MAXİ STAR DAMLA SULAMA BORUSU 12 MİL MAXI STAR T-TAPE DRIP PIPE 12 MIL

Çap Diameter	Et Kalınlığı Wall Thickness	Debi Flow Rate	Paketleme Packaging	Kod Code	Damlama Aralığı Distance
16 mm	12 mil (0,30 mm)	1,0 1,6 2,2 3,5 Lt/h	1.800 metre/top meter/roll	IRX173010-1	10 cm
				IRX173015-1	15 cm
				IRX173020-1	20 cm
				IRX173025-1	30 cm
				IRX173030-1	30 cm
				IRX173033-1	33 cm
				IRX173040-1	40 cm
				IRX173050-1	50 cm
				IRX173060-1	60 cm

#### MAXİ STAR DAMLA SULAMA BORUSU 16 MİL MAXI STAR T-TAPE DRIP PIPE 16 MIL

Çap Diameter	Et Kalınlığı Wall Thickness	Debi Flow Rate	Paketleme Packaging	Kod Code	Damlama Aralığı Distance
16 mm	16 mil (0,40 mm)	1,0 1,6 2,2 3,5 Lt/h	1.500 metre/top meter/roll	IRX174010-1	10 cm
				IRX174015-1	15 cm
				IRX174020-1	20 cm
				IRX174025-1	30 cm
				IRX174030-1	30 cm
				IRX174033-1	33 cm
				IRX174040-1	40 cm
				IRX174050-1	50 cm
				IRX174060-1	60 cm

#### 22 mm MAXİ STAR DAMLA SULAMA BORUSU 22 mm MAXI STAR T-TAPE DRIP PIPE

Çap Diameter	Et Kalınlığı Wall Thickness	Debi Flow Rate	Paketleme Packaging	Kod Code	Damlama Aralığı Distance
22 mm	10 mil (0,25mm)	1,0 1,6 2,2 Lt/h	1.400 metre/top meter/roll	IR222520-1	20 cm
				IR222525-1	25 cm
				IR222530-1	30 cm
	12 mil (0,30mm)			IR223020-2	20 cm
				IR223025-2	25 cm
				IR223030-2	30 cm

#### 25 mm MAXİ STAR DAMLA SULAMA BORUSU 25 mm MAXI STAR T-TAPE DRIP PIPE

Çap Diameter	Et Kalınlığı Wall Thickness	Debi Flow Rate	Paketleme Packaging	Kod Code	Damlama Aralığı Distance
25 mm	12 mil (0,30mm)	1,0 1,6 2,2 Lt/h	1.000 metre/top meter/roll	IR253020-1	20 cm
				IR253025-1	25 cm
				IR253030-1	30 cm

Damlama Sulama Borusu  
Drip Irrigation Pipe



# DAMLA SULAMA BORUSU DRIP IRRIGATION PIPE



Damla Sulama Borusu  
Drip Irrigation Pipe

## STAR-T MAXI LOADING PROGRAM

### WITH PALLET

### 20" DC CONTAINER

### WITHOUT PALLET

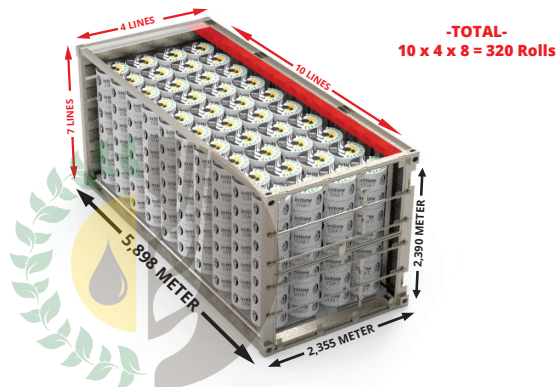
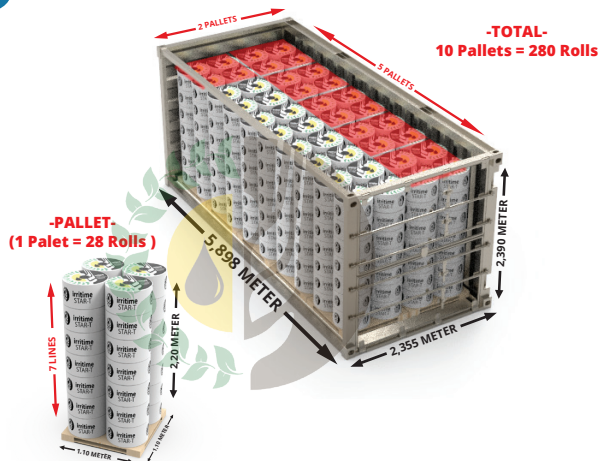

### 40" HIGH CUBE CONTAINER

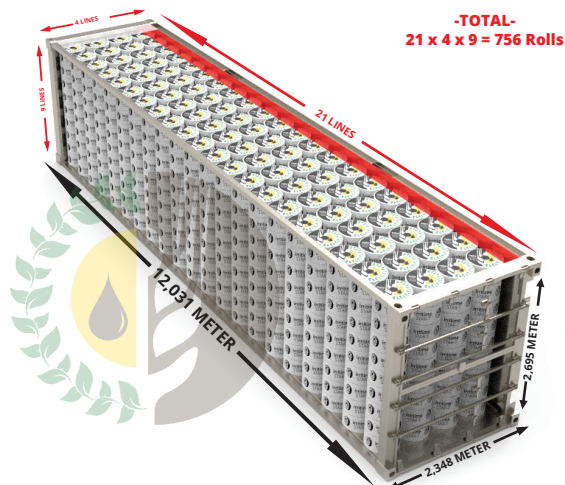
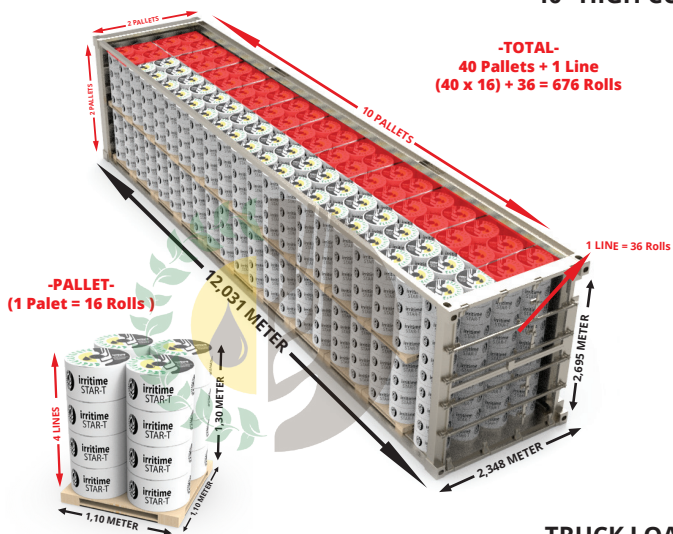

### TRUCK LOADING PROGRAM

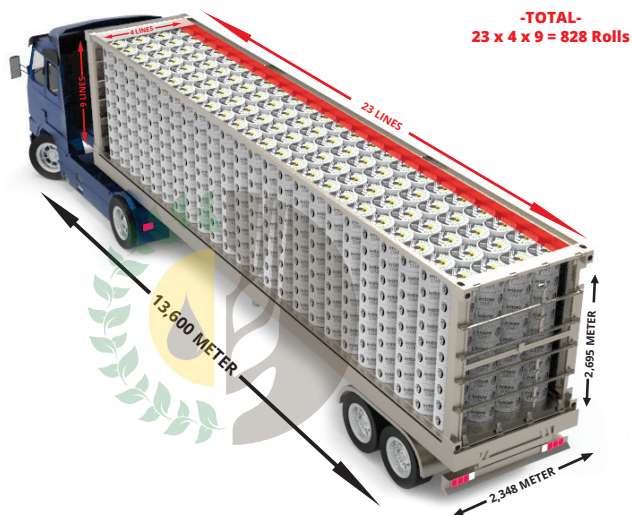
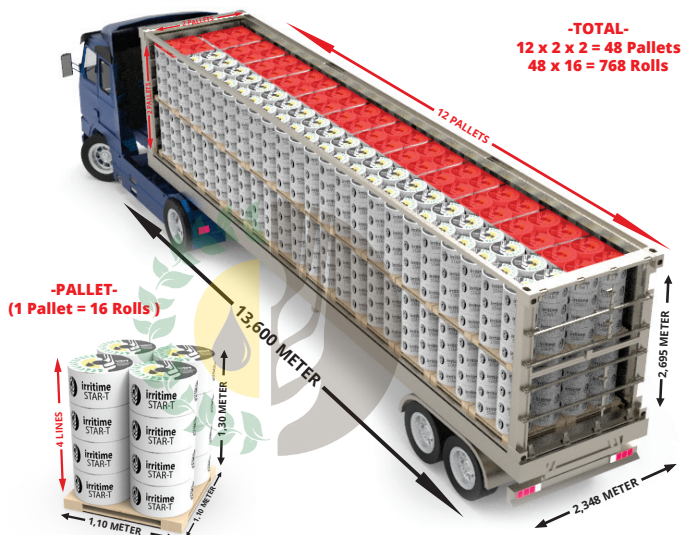



## STAR-L

### 6 ATÜ ALÇAK YOĞUNLUK UV KANGAL BORU 6 BARS LDPE UV COIL PIPES

Kod Code	Çap Diameter Ø	BAR Maximum Recommended Pressure	Rulo Uzunluğu Roll Length
IR-LPE 25-6	25 mm	6 BARS (ATÜ)	200 meters
IR-LPE 32-6	32 mm		200 meters
IR-LPE 40-6	40 mm		100 meters
IR-LPE 50-6	50 mm		100 meters
IR-LPE 63-6	63 mm		100 meters
IR-LPE 75-6	75 mm		100 meters
IR-LPE 90-6	90 mm		100 meters

### 10 ATÜ ALÇAK YOĞUNLUK UV KANGAL BORU 10 BARS LDPE UV COIL PIPES

Kod Code	Çap Diameter Ø	BAR Maximum Recommended Pressure	Rulo Uzunluğu Roll Length
IR-LPE 25-10	25 mm	10 BARS (ATÜ)	200 meters
IR-LPE 32-10	32 mm		200 meters
IR-LPE 40-10	40 mm		100 meters
IR-LPE 50-10	50 mm		100 meters
IR-LPE 63-10	63 mm		100 meters
IR-LPE 75-10	75 mm		100 meters
IR-LPE 90-10	90 mm		100 meters
IR-LPE 110-10	110 mm		50 meters

### 16 ATÜ ALÇAK YOĞUNLUK UV KANGAL BORU 16 BARS LDPE UV COIL PIPES

Kod Code	Çap Diameter Ø	BAR Maximum Recommended Pressure	Rulo Uzunluğu Roll Length
IR-LPE 32-16	32 mm	16 BARS (ATÜ)	100 meters
IR-LPE 40-16	40 mm		100 meters
IR-LPE 50-16	50 mm		100 meters
IR-LPE 63-16	63 mm		100 meters
IR-LPE 75-16	75 mm		100 meters
IR-LPE 90-16	90 mm		100 meters
IR-LPE 110-16	110 mm		50 meters

# **DAMLAMA EK PARÇALARI** **DRIP IRRIGATION FITTINGS**





## SİYAH SERİ KURTAĞZI EK PARÇALAR BLACK SERIES BARBED FITTINGS

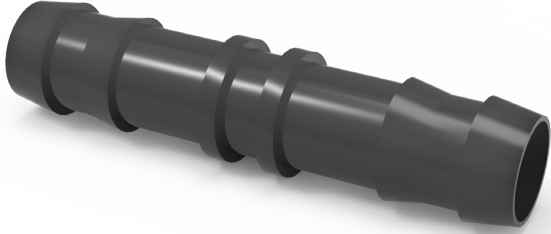

Kod Code	Kurtağzı Nipel Barbed Nipple	Paketleme-Koli Packaging-Box
IR-BKN-1313	13X13mm	
IR-BKN-1616	16X16mm	1.050
IR-BKN-2020	20X20mm	750
IR-BKN-2525	25X25mm	
IR-BKN-3232	32X32mm	

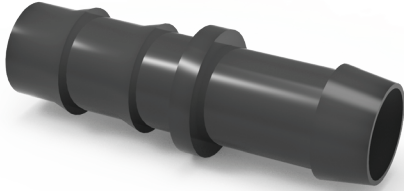

Kod Code	Kurtağzı Conta Çıkış Nipel Barbed Start Nipple	Paketleme-Koli Packaging-Box
IR-BKCN-1616	16X16mm	1.350
IR-BKCN-2020	20X20mm	800



Kod Code	Kurtağzı Te Barbed Tee	Paketleme-Koli Packaging-Box
IR-BKT-1313	13X13X13mm	
IR-BKT-1616	16X16X16mm	750
IR-BKT-2016	20X16X20mm	550
IR-BKT-2020	20X20X20mm	450
IR-BKT-2516	25X16X25mm	250
IR-BKT-2520	25X20X25mm	250
IR-BKT-2525	25X25X25mm	250
IR-BKT-3216	32X16X32mm	150
IR-BKT-3220	32X20X32mm	150
IR-BKT-3225	32X25X32mm	150
IR-BKT-3232	32X32X32mm	150



Kod Code	Kurtağzı Dirsek Barbed Elbow	Paketleme-Koli Packaging-Box
IR-BKD-1616	16X16mm	1.050
IR-BKD-2020	20X20mm	800

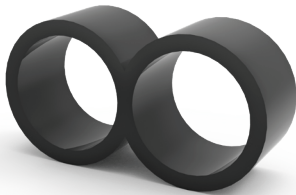

Kod Code	Gözlük Körtapa 8 Type End Cap	Paketleme-Koli Packaging-Box
IR-BGKT-16	16 mm	1.500
IR-BGKT-20	20 mm	1.000
IR-BGKT-25	25 mm	500
IR-BGKT-32	32 mm	300



# DAMLA SULAMA EK PARÇALARI DRIP IRRIGATION FITTINGS



Damla Sulama Ek Parçaları  
Drip Irrigation Fittings

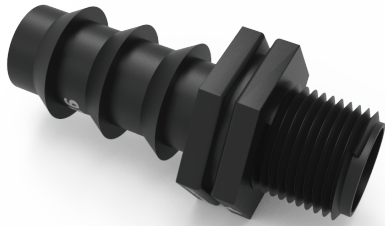
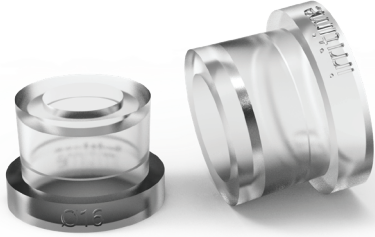

Kod Code	Konik Conta Conical Start O-Ring	Paketleme-Koli Packaging-Box
IR-KC-16	16 mm	2.250
IR-KC-20	20 mm	2.000

Kod Code	Düz Conta Straight O-Ring	Paketleme-Koli Packaging-Box
IR-KDC-16	16 mm	2.000
IR-KDC-20	20 mm	1.650

Kod Code	Kurtağzı Erkek Nipel Barbed Male Nipple	Paketleme-Koli Packaging-Box
IR-KEN-161/2	16 x 1/2"	400
IR-KEN-163/4	16 x 3/4"	400
IR-KEN-201/2	20 x 1/2"	300
IR-KEN-203/4	20 x 3/4"	300
IR-KEN-253/4	25 x 3/4"	250
IR-KEN-251	25 x 1"	250
IR-KEN-321	32 x 1"	100

Kod Code	Kurtağzı Erkek Te Barbed Male Tee	Paketleme-Koli Packaging-Box
IR-KET-161/2	16 x 1/2" x 16	600
IR-KET-163/4	16 x 3/4" x 16	500
IR-KET-201/2	20 x 1/2" x 20	400
IR-KET-203/4	20 x 3/4" x 20	300
IR-KET-201	20 x 1" x 20	250

Kod Code	Kurtağzı Erkek Dirsek Barbed Male Elbow	Paketleme-Koli Packaging-Box
IR-KED-161/2	16 x 1/2"	1000
IR-KED-163/4	16 x 3/4"	850
IR-KED-201/2	20 x 1/2"	600
IR-KED-203/4	20 x 3/4"	550

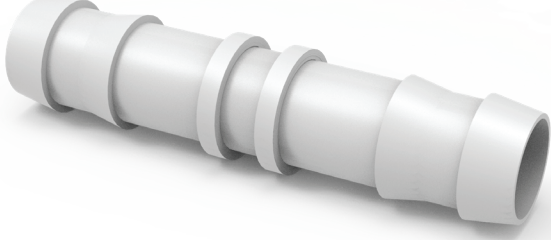
GRİ SERİ KURTAĞZI EK PARÇALAR  
GREY SERIES BARBED FITTINGS

Kod Code	Kurtağzi Nipel Barbed Nipple	Paketleme-Koli Packaging-Box
IR-KN-1313	13X13mm	
IR-KN-1616	16X16mm	1.050
IR-KN-2020	20X20mm	700

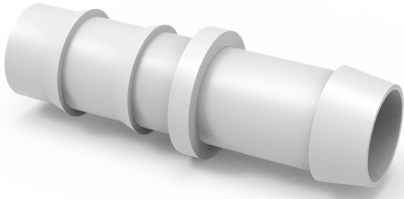

Kod Code	Kurtağzi Conta Çıkış Nipeli Barbed Start Nipple	Paketleme-Koli Packaging-Box
IR-KCN-1616	16X16mm	1.500
IR-KCN-1620	20X20mm	1000

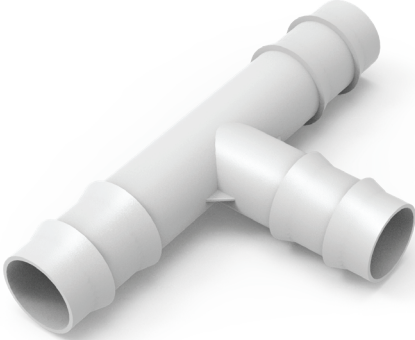

Kod Code	Kurtağzi Te Barbed Tee	Paketleme-Koli Packaging-Box
IR-KT-1313	13X13X13mm	
IR-KT-1616	16X16X16mm	700
IR-KT-2016	20X16X20mm	500
IR-KT-2020	20X20X20mm	400



Kod Code	Kurtağzi Dirsek Barbed Elbow	Paketleme-Koli Packaging-Box
IR-KD-1616	16X16mm	1.050
IR-KD-2020	20X20mm	1.000

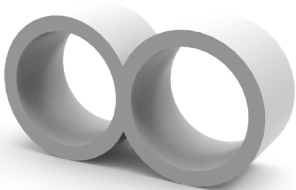

Kod Code	Gözlük Körtapa 8 Type End Cap	Paketleme-Koli Packaging-Box
IR-GKT-16	16 mm	1.500



# DAMLA SULAMA EK PARÇALARI DRIP IRRIGATION FITTINGS



Damla Sulama Ek Parçaları  
Drip Irrigation Fittings

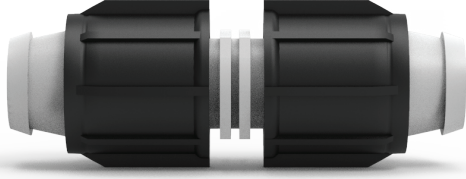

Kod Code	Somunlu Nipel Locked Nipple	Paketleme-Koli Packaging-Box
IR-SEN-1717	17X17mm	450
IR-SEN-2222	22X22mm	255

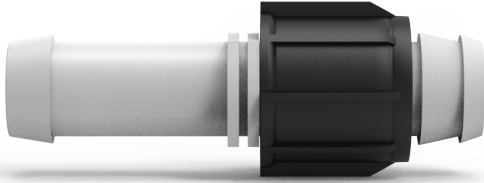

Kod Code	Kurtağızı Conta Çıkış & Somunlu Nipel Nipple Barbed Start & Locked	Paketleme-Koli Packaging-Box
IR-KCSEN-1716	17X16mm	600
IR-KCSEN-2220	22X20mm	375

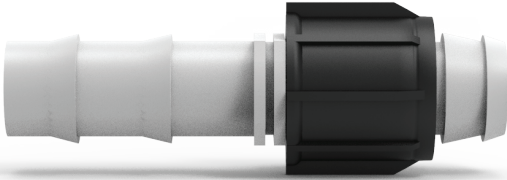

Kod Code	Kurtağızı & Somunlu Nipel Nipple Barbed & Locked	Paketleme-Koli Packaging-Box
IR-KSEN-1716	17X16mm	600

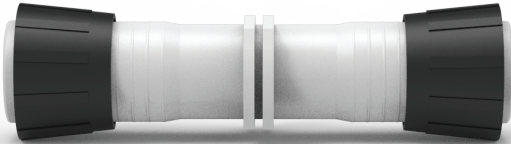

Kod Code	Yüzüklü Nipel Nipple Pressed	Paketleme-Koli Packaging-Box
IR-YEN-1717	17X17mm	750
IR-YEN-2222	22X22mm	375

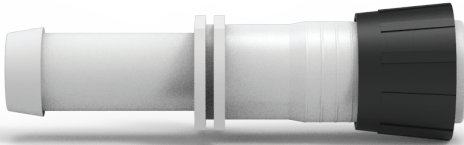

Kod Code	Kurtağızı Conta Çıkış & Yüzüklü Nipel Nipple Barbed Start & Pressed	Paketleme-Koli Packaging-Box
IR-KCYEN-1716	17X16mm	900
IR-KCYEN-2220	22X20mm	450

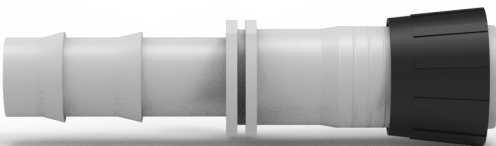

Kod Code	Kurtağızı & Yüzüklü Nipel Nipple Barbed & Pressed	Paketleme-Koli Packaging-Box
IR-KYEN-1716	17X16mm	900

## MİNİ VANALAR MINI VALVES



Kod Code	Kurtağızlı Mini Vana Mini Valve Barbed	Paketleme-Koli Packaging-Box
IR-KMV-1616	16X16mm	250
IR-KMV-2016	16X20mm	200
IR-KMV-2020	20X20mm	200
IR-KMV-2525	25X25mm	100

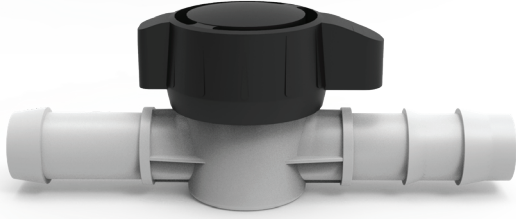

Kod Code	Kurtağızlı Conta Çıkış Mini Vana Mini Valve Barbed Start & Barbed	Paketleme-Koli Packaging-Box
IR-KCMV-1616	16X16mm	250
IR-KCMV-2020	20X20mm	200
IR-KCMV-2520	25X20mm	100

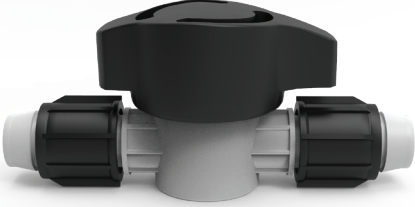

Kod Code	Somunlu Mini Vana Mini Valve Locked For Tape	Paketleme-Koli Packaging-Box
IR-SMV-1717	17X17mm	150
IR-SMV-2222	22X22mm	100
IR-SMV-2525	25X25mm	80

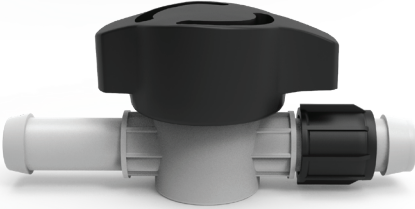

Kod Code	Kurt Ağız Çıkış & Somunlu Mini Vana Mini Valve Barbed Start & Locked	Paketleme-Koli Packaging-Box
IR-KCSMV-1617	16X17mm	225
IR-KCSMV-2020	20X20mm	150
IR-KCSMV-2022	22X20mm	150
IR-KCSMV-2025	25X20mm	100

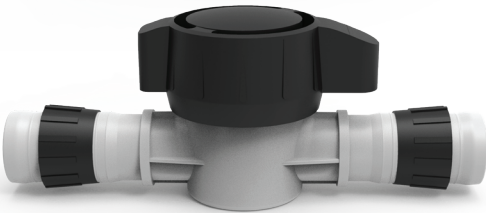

Kod Code	Yüzüklü Mini Vana Mini Valve Pressed For Tape	Paketleme-Koli Packaging-Box
IR-YMV-1717	17X17mm	200
IR-YMV-2222	22X22mm	150
IR-YMV-2525	25X25mm	100

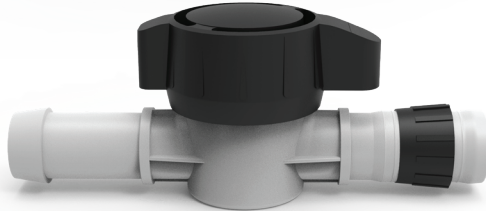

Kod Code	Kurt Ağız Conta Çıkış & Yüzüklü Mini Vana Mini Valve Barbed Start & Pressed	Paketleme-Koli Packaging-Box
IR-KCYMV-1617	16X17mm	200
IR-KCYMV-2220	20X22mm	300
IR-KCYMV-2520	20X25mm	200

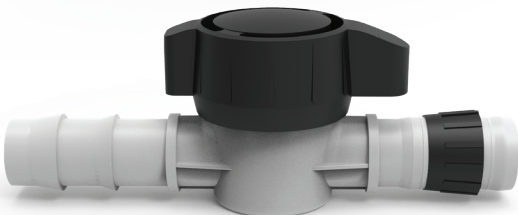

Kod Code	Kurt Ağız & Yüzüklü Mini Vana Mini Valve Barbed & Pressed	Paketleme-Koli Packaging-Box
IR-KYMV-1617	16X17mm	200
IR-KYMV-2220	20X22mm	300
IR-KYMV-2520	20X25mm	200



# DAMLA SULAMA EK PARÇALARI DRIP IRRIGATION FITTINGS



Damla Sulama Ek Parçaları  
Drip Irrigation Fittings

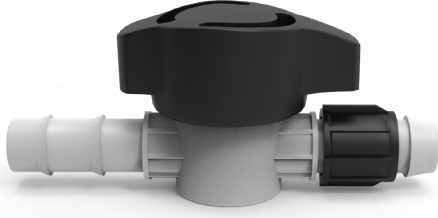

Kod Code	Kurt Ağzı & Somunlu Mini Vana Mini Valve Barbed & Locked	Paketleme-Koli Packaging-Box
IR-KSMV-1617	16X17mm	200
IR-KSMV-2020	20X20mm	200
IR-KSMV-2022	22X20mm	150
IR-KSMV-2025	25X20mm	100

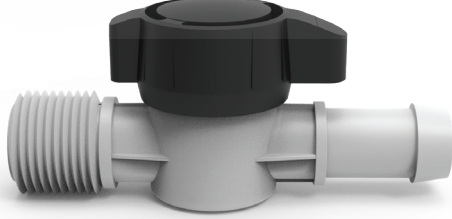

Kod Code	Kurt Ağzı Conta Çıkış & Dış Dişli Mini Vana Mini Valve Male & Start Barbed	Paketleme-Koli Packaging-Box
IR-KCDMV-1/216	½" X 16mm	200
IR-KCDMV-3/416	¾" X 16mm	200

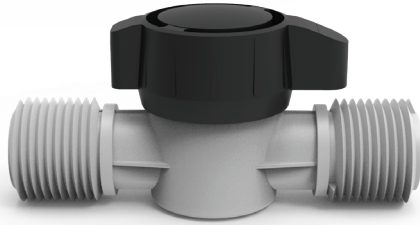

Kod Code	Dış Dişli Mini Vana Mini Valve Male	Paketleme-Koli Packaging-Box
IR-DDMV-1/2	½" X ½"	200
IR-DDMV-3/4	¾" X ¾"	200
IR-DDMV-1/2-3/4	½" X ¾"	200

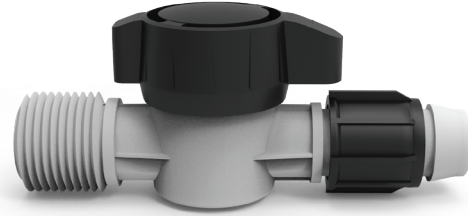

Kod Code	Dış Dişli & Somunlu Mini Vana Mini Valve Male & Locked	Paketleme-Koli Packaging-Box
IR-SDMV-1/217	½" X 17mm	200
IR-SDMV-1/220	½" X 20mm	200
IR-SDMV-1/222	½" X 22mm	150
IR-SDMV-1/225	½" X 25mm	100
IR-SDMV-3/417	¾" X 17mm	200
IR-SDMV-3/420	¾" X 20mm	200
IR-SDMV-3/422	¾" X 22mm	150
IR-SDMV-3/425	¾" X 25mm	100

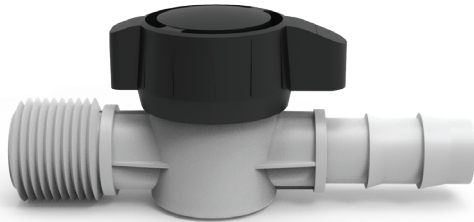

Kod Code	Dış Dişli & Kurt Ağzı Mini Vana Mini Valve Male & Barbed	Paketleme-Koli Packaging-Box
IR-KDMV-1/216	½" X 16mm	200
IR-KDMV-1/220	½" X 20mm	200
IR-KDMV-1/225	½" X 25mm	100
IR-KDMV-3/416	¾" X 16mm	200
IR-KDMV-3/420	¾" X 20mm	200
IR-KDMV-3/425	¾" X 25mm	100

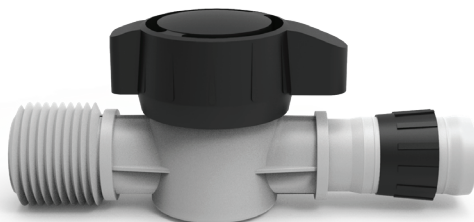

Kod Code	Dış Dişli & Yüzüklü Mini Vana Mini Valve Male & Pressed	Paketleme-Koli Packaging-Box
IR-YDMV-1/217	½" X 17mm	200
IR-YDMV-1/222	½" X 22mm	300
IR-YDMV-1/225	½" X 25mm	200
IR-YDMV-3/417	¾" X 17mm	200
IR-YDMV-3/422	¾" X 22mm	300
IR-YDMV-3/425	¾" X 25mm	200

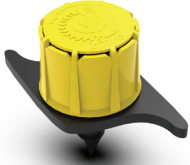
HAT ÜSTÜ DAMLATICILAR  
ONLINE DRIPPERS

Kod Code	Debi Ayarlı Hat Üstü Damlatıcı ONLINE DRIPPER	Paketleme-Koli Packaging-Box
HAT-70	0-70 lph	4000

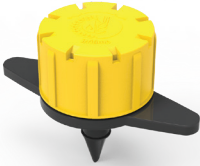

Kod Code	Debi Ayarlı Hat Üstü Damlatıcı ONLINE DRIPPER	Paketleme-Koli Packaging-Box
HAT-100	0-100 lph	2000



Kod Code	Debi Ayarlı Hat Üstü Damlatıcı ONLINE DRIPPER	Paketleme-Koli Packaging-Box
HAT-140	0-140 lph	2000



Kod Code	T Tipi Hat Üstü Damlatıcı T Type Online Dripper	Paketleme-Koli Packaging-Box
IR-OTD-8	8 Lt/h-Lt/sa	4000



# DAMLA SULAMA EK PARÇALARI DRIP IRRIGATION FITTINGS



*elf*

Damla Sulama Ek Parçaları  
Drip Irrigation Fittings

Kod Code	ELF PC Hat Üstü Damlatıcı ELF PC DRIPPER	Renk Colour	Paketleme-Koli Packaging-Box
IR-OPD-2	2 Lt/h-Lt/sa	Blue - Mavi	1.500
IR-OPD-4	4 Lt/h-Lt/sa	Green - Yeşil	1.500
IR-OPD-8	8 Lt/h-Lt/sa	Brown - Kahverengi	1.500
IR-OPD-12	12 Lt/h-Lt/sa	Red - Kırmızı	1.500
IR-OPD-16	16 Lt/h-Lt/sa	Purple - Mor	1.500

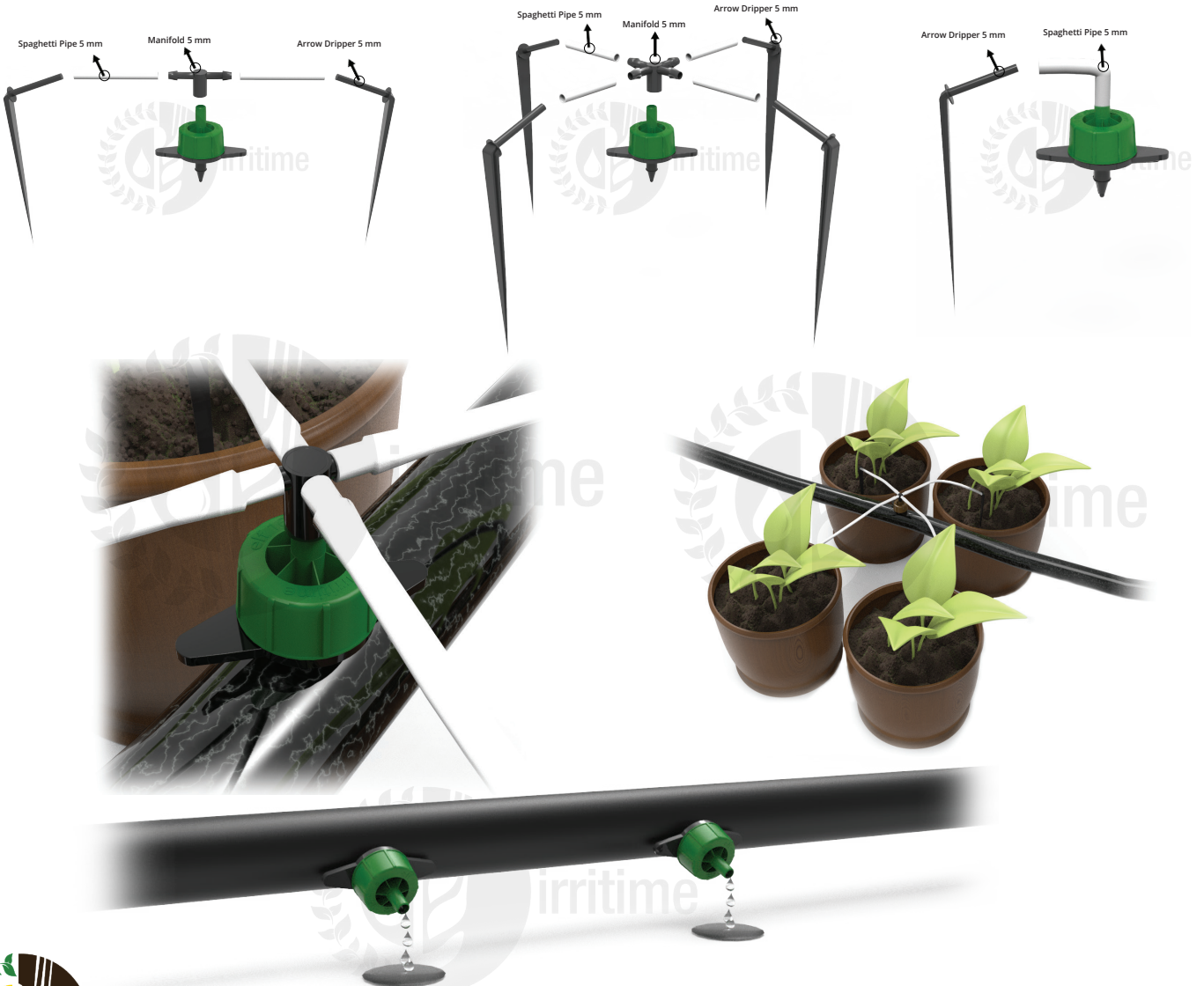





Kod Code	Saksı Sulama Kazığı Set Hydroponic Stake Set	Paketleme-Koli Packaging-Box
IR-401-5	5 mm Midi Hortum Boyu : 50cm 4lt. Pipe length : 50cm 4lt.	100
IR-401-7	7 mm Maxi Hortum Boyu : 50cm 4lt. Pipe length : 50cm 4lt.	100

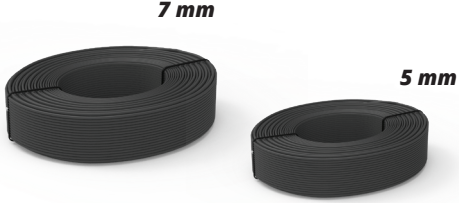

Kod Code	Pvc Spagetti Boru Spaghetti Pipe	Paketleme-Koli Packaging-Box
IR-407-5	5 mm	100 mt
IR-407-7	7 mm	100 mt
IR-407-12	12 mm	100 mt



Kod Code	Saksı Sulama Kazığı Hydroponic Stake	Paketleme-Koli Packaging-Box
IR-405MN-5	Mini 5 mm - 9 cm - Flow Rate 2 lt/h	500
IR-405MD-5	Midi 5 mm - 15 cm - Flow Rate 2 lt/h	500
IR-405MX-7	Maxi 7 mm - 15 cm - Flow Rate 4 lt/h	500



Kod Code	5 mm Dağıtıcı 5 mm Manifold	Paketleme-Koli Packaging-Box
IR-425	2'li-Dual	100
IR-426	4'lü-Quadruplet	100



Kod Code	5 mm Vidalı Start Çıkış 5 mm Start Adaptor	Paketleme-Koli Packaging-Box
IR-223	Tek Taraflı - Single Sided	500
IR-224	Çift Taraflı - Double Sided	500

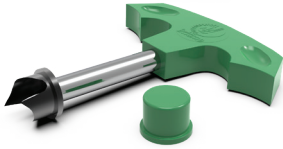

Kod Code	Delme Aparatı MANUAL PUNCH	Paketleme-Koli Packaging-Box
IR-DELA-16	16 mm	200
IR-DELA-20	20 mm	200

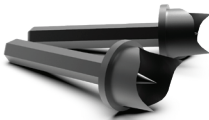

Kod Code	Matkap Ucu Delme Aparatı DRILL PUNCH	Paketleme-Koli Packaging-Box
IR-DELAM-16	16 mm - Drill	500
IR-DELAM-20	20 mm - Drill	500



Kod Code	Delme Aparatı MANUAL PUNCH	Paketleme-Koli Packaging-Box
IR-DELA-03	3 mm	200
IR-DELA-08	8 mm	200



# DAMLA SULAMA EK PARÇALARI DRIP IRRIGATION FITTINGS



Damla Sulama Ek Parçaları  
Drip Irrigation Fittings



Kod Code	Körtapa END CAP	Paketleme-Koli Packaging-Box
IR-0179	4 mm	100



Kod Code	Çift Etkili Hava Vantuzu DOUBLE-ACTING AIR RELEASE VALVE	Paketleme-Koli Packaging-Box
IR-DAV-1	1"	40



Kod Code	Tek Etkili Hava Vantuzu SINGLE-ACTING AIR RELEASE VALVE	Paketleme-Koli Packaging-Box
IR-SAV-3/4	3/4"	40
IR-SAV-1	1"	40



Kod Code	Boru Sabitleme Kazığı PIPE STABILISER	Paketleme-Koli Packaging-Box
IR-PSS-16	16 mm - Short - Kısa	300



Kod Code	Boru Askısı PIPE HANGING HOOK	Paketleme-Koli Packaging-Box
IR-PHH-16	16 mm	1000
IR-PHH-22	22 mm	1000



Kod Code	Boru Sıkma Keleçesi OFFTAKE CLAMP	Paketleme-Koli Packaging-Box
IR-OC-16	16 mm	1000
IR-OC-20	20 mm	1000

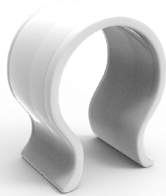

Kod Code	Mandallı Sera Klibi GREENHOUSE CLIP	Paketleme-Koli Packaging-Box
IR-GC-22	22 mm	1000
IR-GC-27	27 mm	1000
IR-GC-32	32 mm	1000

## BOX LOADING PROGRAM

### WITH PALLET

### 20" DC CONTAINER

### WITHOUT PALLET

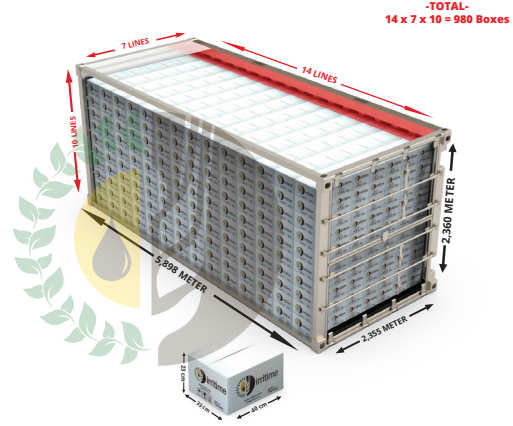
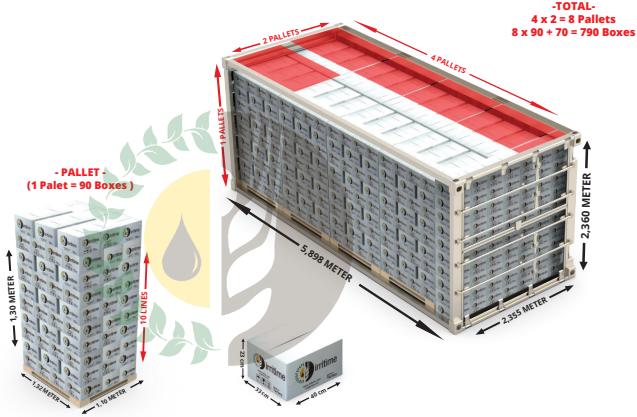

Damla Sulama Ek Parçaları  
Drip Irrigation Fittings

### 40" HIGH CUBE CONTAINER

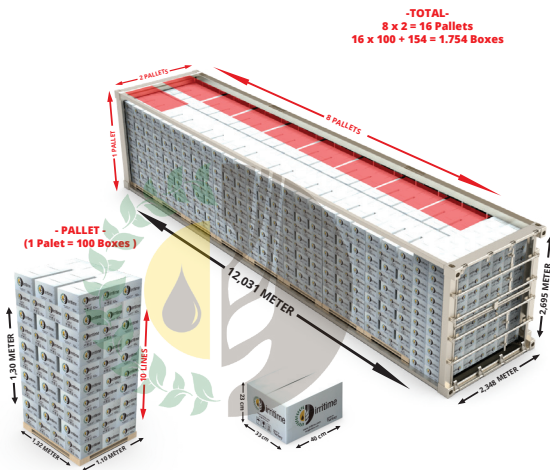

### TRUCK LOADING PROGRAM

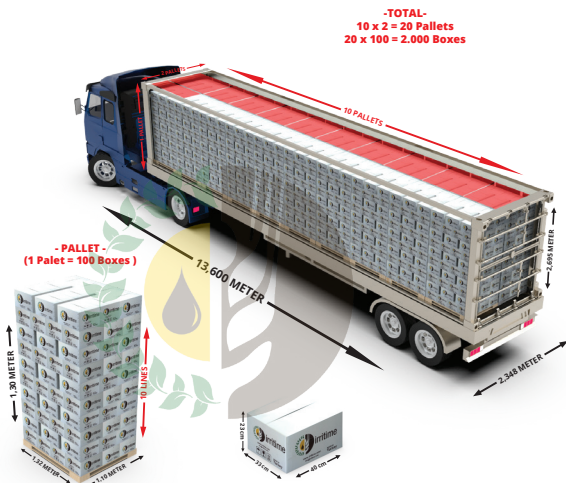

# **MIKRO YAĞMURLAMA** **MICRO SPRINKLER**



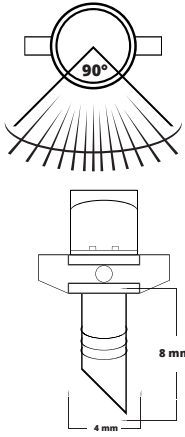

## 90° Radius Stable Mini Sprink

Kod Code	Özellik Property	Paketleme-Koli Packaging-Box
IR-406-90	90° - Yeşil-Green - 120 lt./h	500

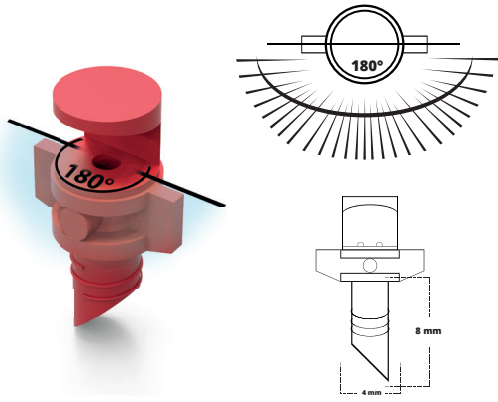

## 180° Radius Stable Mini Sprink

Kod Code	Özellik Property	Paketleme-Koli Packaging-Box
IR-406-180	180° - Kırmızı-Red - 120 lt./h	500

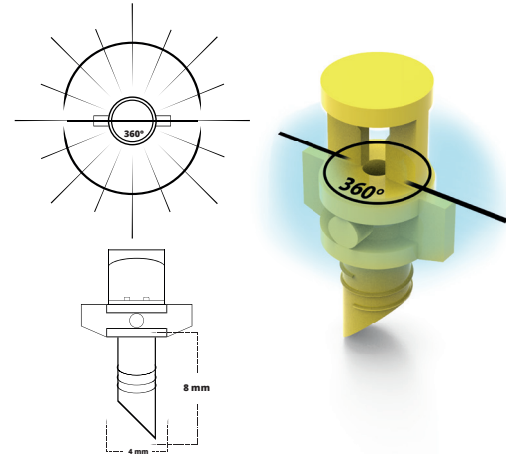

## 360° Radius Stable Mini Sprink

Kod Code	Özellik Property	Paketleme-Koli Packaging-Box
IR-406-360	360° - Sarı-Yellow - 120 lt./h	500



### Riser



## Radius Stable Sprayer Set

Kod Code	Özellik Property	Paketleme-Koli Packaging-Box
IR-406-90S	90° - Yeşil-Green - 120 lt./h	500
IR-406-180S	180° - Kırmızı-Red - 120 lt./h	500
IR-406-360S	360° - Sarı-Yellow - 120 lt./h	500
IR-406-R	Riser 20 cm Length	500



# MİKRO YAĞMURLAMA SİSTEMLERİ MICRO SPRINKLER



Kod Code	Kazıklı Mini Sprink Seti Rotating Sprayer Set	Paketleme-Koli Packaging-Box
IR-400-80	Yeşil-Green : 80 lt.	100
IR-400-120	Kırmızı-Red : 120 lt.	100
IR-400-160	Sarı-Yellow : 160 lt.	100



Kod Code	Mini Sprink Rotating Sprayer	Paketleme-Koli Packaging-Box
IR-402-80	Yeşil-Green : 80 lt.	100
IR-402-120	Kırmızı-Red : 120 lt.	100
IR-402-160	Sarı-Yellow : 160 lt.	100

Mikro Yağmurlama Sistemleri  
Micro Sprinkler

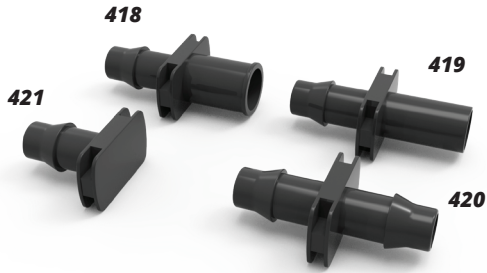

Kod Code	7 mm Nozul Adaptör Nipple Adaptor	Paketleme-Koli Packaging-Box
IR-418	Dişi Adaptör - Female Adaptor	500
IR-419	Erkek Adaptör - Male Adaptor	500
IR-420	Ekleme - Adding	500
IR-421	Kör Tapa - End Cap	500

# ***DIŞLİ BAĞLANTI* ELEMANLARI** **THREADED FITTINGS**

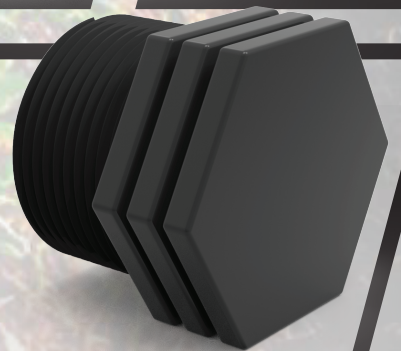
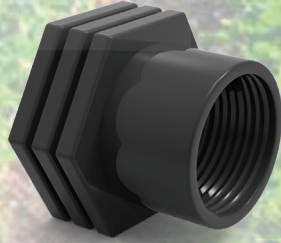



# PE EK PARÇALAR PE COMPRESSION FITTINGS

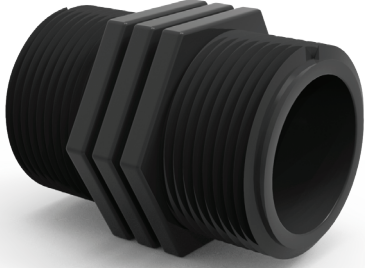

Kod Code	Pe Erkek Dişli Nipel PE MALE NIPPLE	Paketleme Packaging
IR-13511	½" X ½"	50
IR-13522	¾" X ¾"	50
IR-13533	1" X 1"	50
IR-13544	1¼" X 1¼"	25
IR-13555	1½" X 1½"	25
IR-13566	2" X 2"	25
IR-13577	2½" X 2½"	12
IR-13588	3" X 3"	12
IR-13599	4" X 4"	6



Kod Code	Pe Dişli Nipel PE FEMALE NIPPLE	Paketleme Packaging
IR-13711	½" X ½"	50
IR-13722	¾" X ¾"	50
IR-13733	1" X 1"	50
IR-13744	1¼" X 1¼"	25
IR-13755	1½" X 1½"	15
IR-13766	2" X 2"	12
IR-13777	2½" X 2½"	12
IR-13788	3" X 3"	6
IR-13799	4" X 4"	4



Kod Code	Pe Erkek Dişli Redüksiyon Nipel PE MALE REDUCTION NIPPLE	Paketleme Packaging
IR-13621	¾" X ½"	50
IR-13631	1" X ½"	50
IR-13632	1" X ¾"	50
IR-13641	1¼" X ½"	25
IR-13642	1¼" X ¾"	25
IR-13643	1¼" X 1"	25
IR-13652	1½" X ¾"	25
IR-13653	1½" X 1"	25
IR-13654	1½" X 1¼"	25
IR-13663	2" X 1"	25
IR-13664	2" X 1¼"	25
IR-13665	2" X 1½"	25
IR-13674	2½" X 1¼"	12
IR-13675	2½" X 1½"	12
IR-13676	2½" X 2"	12
IR-13685	3" X 1½"	12
IR-13686	3" X 2"	12
IR-13687	3" X 2½"	12
IR-13696	4" X 2"	6
IR-13697	4" X 2½"	6
IR-13698	4" X 3"	6

PE EK Parçalar  
PE Compression Fittings





Kod Code	Pe Erkek Dişli Te PE MALE TEE	Paketleme Packaging
IR-13111	½" X ½" X ½"	25
IR-13112	½" X ¾" X ½"	25
IR-13121	¾" X ½" X ¾"	25
IR-13122	¾" X ¾" X ¾"	25
IR-13123	¾" X 1" X ¾"	25
IR-13131	1" X ½" X 1"	25
IR-13132	1" X ¾" X 1"	25
IR-13133	1" X 1" X 1"	25
IR-13141	1¼" X ½" X 1¼"	15
IR-13142	1¼" X ¾" X 1¼"	15
IR-13143	1¼" X 1" X 1¼"	15
IR-13144	1¼" X 1¼" X 1¼"	15
IR-13155	1½" X 1½" X 1½"	10
IR-13165	2" X 1½" X 2"	6
IR-13166	2" X 2" X 2"	6
IR-13177	2½" X 2½" X 2½"	3
IR-13188	3" X 3" X 3"	2
IR-13199	4" X 4" X 4"	1



Kod Code	Pe Erkek Dişli Dirsek PE MALE ELBOW	Paketleme Packaging
IR-13311	½" X ½"	25
IR-13321	¾" X ½"	25
IR-13322	¾" X ¾"	25
IR-13331	1" X ½"	25
IR-13332	1" X ¾"	25
IR-13333	1" X 1"	25
IR-13341	1¼" X ½"	15
IR-13342	1¼" X ¾"	15
IR-13343	1¼" X 1"	15
IR-13344	1¼" X 1¼"	15
IR-13355	1½" X 1½"	10
IR-13364	2" X 1¼"	6
IR-13365	2" X 1½"	6
IR-13366	2" X 2"	6
IR-13377	2½" X 2½"	4
IR-13388	3" X 3"	2
IR-13399	4" X 4"	1

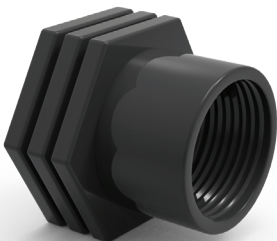

Kod Code	Pe Dişli Körtapa PE FEMALE END CAP	Paketleme Packaging
IR-14211	½"	50
IR-14222	¾"	50
IR-14233	1"	50



# PE EK PARÇALAR PE COMPRESSION FITTINGS



Kod Code	Pe Erkek-Dişi Redüksiyon Nipel PE MALE-FEMALE REDUCTION NIPPLE	Paketleme Packaging
IR-13911	½" X ½"	50
IR-13912	½" X ¾"	50
IR-13913	½" X 1"	50
IR-13922	¾" X ¾"	50
IR-13923	¾" X 1"	50
IR-13933	1" X 1"	50
IR-13944	1¼" X 1¼"	15
IR-13945	1¼" X 1½"	15
IR-13955	1½" X 1½"	15
IR-13956	1½" X 2"	15
IR-13957	1½" X 2½"	15
IR-13966	2" X 2"	15
IR-13967	2" X 2½"	12
IR-13968	2" X 3"	6
IR-13969	2" X 4"	4
IR-13977	2½" X 2½"	12
IR-13978	2½" X 3"	6
IR-13979	2½" X 4"	4
IR-13988	3" X 3"	6
IR-13989	3" X 4"	4
IR-13999	4" X 4"	4

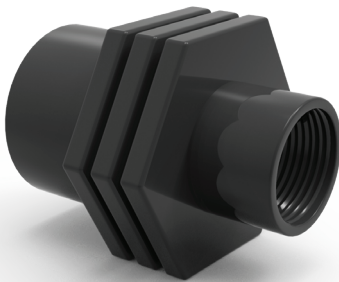

Kod Code	Pe Dişi Redüksiyon Nipeli PE FEMALE REDUCTION NIPPLE	Paketleme Packaging
IR-13821	¾" X ½"	50
IR-13831	1" X ½"	50
IR-13832	1" X ¾"	50
IR-13842	1¼" X ¾"	25
IR-13843	1¼" X 1"	25
IR-13853	1½" X 1"	15
IR-13854	1½" X 1¼"	15
IR-13864	2" X 1¼"	12
IR-13865	2" X 1½"	12
IR-13874	2½" X 1¼"	12
IR-13875	2½" X 1½"	12
IR-13876	2½" X 2"	12
IR-13886	3" X 2"	6
IR-13887	3" X 2½"	6
IR-13896	4" X 2"	4
IR-13897	4" X 2½"	4
IR-13898	4" X 3"	4

PE EK Parçalar  
PE Compression Fittings



Kod Code	Pe Dişi Te PE FEMALE TEE	Paketleme Packaging
IR-13271	½" X ½" X ½"	25
IR-13272	¾" X ¾" X ¾"	25
IR-13273	1" X 1" X 1"	25
IR-13274	1¼" X 1¼" X 1¼"	15
IR-13275	1½" X 1½" X 1½"	10
IR-13276	2" X 2" X 2"	6
IR-13277	2½" X 2½" X 2½"	3
IR-13278	3" X 3" X 3"	2
IR-13279	4" X 4" X 4"	1

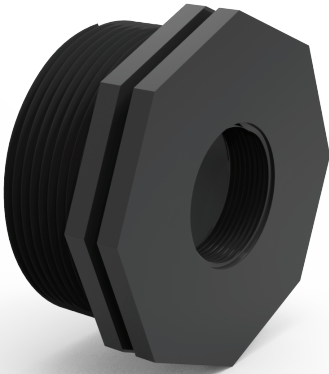

Kod Code	Pe Erkek-Dişi Redüksiyon Nipel PE MALE-FEMALE REDUCTION NIPPLE	Paketleme Packaging
IR-13921	¾" X ½"	50
IR-13931	1" X ½"	50
IR-13932	1" X ¾"	50
IR-13941	1¼" X ½"	25
IR-13942	1¼" X ¾"	25
IR-13943	1¼" X 1"	25
IR-13951	1½" X ½"	15
IR-13952	1½" X ¾"	15
IR-13953	1½" X 1"	15
IR-13954	1½" X 1¼"	15
IR-13961	2" X ½"	15
IR-13962	2" X ¾"	15
IR-13963	2" X 1"	15
IR-13964	2" X 1¼"	15
IR-13965	2" X 1½"	15
IR-13973	2½" X 1"	12
IR-13974	2½" X 1¼"	12
IR-13975	2½" X 1½"	12
IR-13976	2½" X 2"	12
IR-13984	3" X 1¼"	12
IR-13985	3" X 1½"	12
IR-13986	3" X 2"	12
IR-13987	3" X 2½"	12
IR-13996	4" X 2"	6
IR-13997	4" X 2½"	6
IR-13998	4" X 3"	6



# PE EK PARÇALAR PE COMPRESSION FITTINGS



Kod Code	Pe Erkek Dişi Te PE MALE - FEMALE - MALE TEE	Paketleme Packaging
IR-13211	½" X ½" X ½"	25
IR-13212	½" X ¾" X ½"	25
IR-13221	¾" X ½" X ¾"	25
IR-13222	¾" X ¾" X ¾"	25
IR-13223	¾" X 1" X ¾"	25
IR-13231	1" X ½" X 1"	25
IR-13232	1" X ¾" X 1"	25
IR-13233	1" X 1" X 1"	25
IR-13242	1¼" X ¾" X 1¼"	15
IR-13243	1¼" X 1" X 1¼"	15
IR-13254	1½" X 1¼" X 1½"	10
IR-13255	1½" X 1½" X 1½"	10
IR-13264	2" X 1¼" X 2"	6
IR-13265	2" X 1½" X 2"	6
IR-13266	2" X 2" X 2"	6
IR-13267	2½" X 2½" X 2½"	3
IR-13268	3" X 3" X 3"	2
IR-13269	4" X 4" X 4"	1



Kod Code	Pe Dişi Dirsek PE FEMALE ELBOW	Paketleme Packaging
IR-13471	½" X ½"	25
IR-13472	¾" X ¾"	25
IR-13473	1" X 1"	25
IR-13474	1¼" X 1¼"	15
IR-13475	1½" X 1½"	10
IR-13476	2" X 2"	6
IR-13477	2½" X 2½"	4
IR-13478	3" X 3"	2
IR-13479	4" X 4"	1

PE EK Parçalar  
PE Compression Fittings

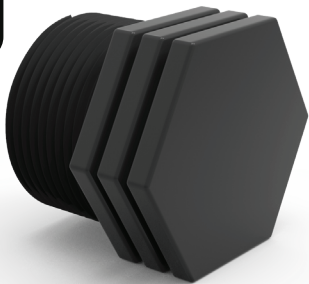

Kod Code	Pe Erkek Kör Tapa PE MALE AND CAP	Paketleme Packaging
IR-14111	½"	50
IR-14122	¾"	50
IR-14133	1"	50
IR-14144	1¼"	25
IR-14155	1½"	15
IR-14166	2"	12
IR-14177	2½"	12
IR-14188	3"	6
IR-14199	4"	4



# **FİLTRE SİSTEMLERİ** **FILTER SYSTEMS**



# FİLTRE SİSTEMLERİ FILTER SYSTEMS



Maks. Çalışma Basıncı  
Max. Working Pressure

8 Bars  
(116 PSI)

Filtrasyon Derecesi  
Filtration Degree

20-50-100-125 Micron

## PLASTİK FİLTRELER | PLASTIC FILTERS (HELİX SYSTEM)

Ebat Size	Tip Type	Kod Code	Filtrasyon Tipi Filtration Type	Debi Flow Rate m <sup>3</sup> /h	Ağırlık Weight kg
2"	SHORT	IR-PMD2	Disc - Disk	20	6
2"	NORMAL	IR-PD2	Disc - Disk	33	7
2"	SUPER	IR-PSD2	Disc - Disk	35	8
2½"	NORMAL	IR-PD25	Disc - Disk	35	7,1
2½"	SUPER	IR-PSD25	Disc - Disk	40	8,1
3"	NORMAL	IR-PD3	Disc - Disk	45	7,2
3"	SUPER	IR-PSD3	Disc - Disk	50	8,2
2"	SHORT	IR-PME2	Mesh - Elek	20	5,2
2"	NORMAL	IR-PE2	Mesh - Elek	30	5,4
2"	SUPER	IR-PSE2	Mesh - Elek	35	6,3
2½"	NORMAL	IR-PE25	Mesh - Elek	35	5,5
2½"	SUPER	R-PSE25	Mesh - Elek	40	6,4
3"	NORMAL	IR-PE3	Mesh - Elek	45	5,6
3"	SUPER	IR-PSE3	Mesh - Elek	50	6,5

Filtre Sistemleri  
Filter System



Maks. Çalışma Basıncı  
Max. Working Pressure

8 Bars  
(116 PSI)

Filtrasyon Derecesi  
Filtration Degree

20-50-100-125 Micron

## PLASTİK İKİZ FİLTRELER | PLASTIC DOUBLE FILTERS (HELİX SYSTEM)

Ebat Size	Tip Type	Kod Code	Filtrasyon Tipi Filtration Type	Debi Flow Rate m <sup>3</sup> /h	Ağırlık Weight kg
3"	NORMAL	IR-DD3	Disc - Disk	50	11,4
3"	SUPER	IR-DDS3	Disc - Disk	70	11,6
4"	NORMAL	IR-DD4	Disc - Disk	60	13,6
4"	SUPER	IR-DDS4	Disc - Disk	80	13,8
3"	NORMAL	IR-DE3	Mesh - Elek	50	8,4
3"	SUPER	IR-DES3	Mesh - Elek	70	8,6
4"	NORMAL	IR-DE4	Mesh - Elek	60	9,8
4"	SUPER	IR-DES4	Mesh - Elek	80	10,0



## irritime/mini



### PLASTİK MİNİ FİLTRE PLASTIC MINI FILTER

Kod Code	Tip Type	Ebat Size	Filtrasyon Tipi Filtration Type	Debi Flow Rate m <sup>3</sup> /h	Ağırlık Weight kg
IR-MPE3/4	MINI	¾"	Mesh - Elek	5	0,30
IR-MPE10	MINI	1"	Mesh - Elek	6	0,30
IR-MPD3/4	MINI	¾"	Disc - Disk	5	0,45
IR-MPD10	MINI	1"	Disc - Disk	6	0,45

## irritime/MIDI



### PLASTİK MİDİ FİLTRE PLASTIC MIDI FILTER

Kod Code	Tip Type	Ebat Size	Filtrasyon Tipi Filtration Type	Debi Flow Rate m <sup>3</sup> /h	Ağırlık Weight kg
IR-MPE10	MIDI	1"	Mesh - Elek	6	0,30
IR-MPE15	MIDI	1½"	Mesh - Elek	15	0,75
IR-MPD10	MIDI	1"	Disc - Disk	6	0,45
IR-MPD15	MIDI	1½"	Disc - Disk	15	1,00

## irritime/MAXI



### PLASTİK MAXİ FİLTRE PLASTIC MAXI FILTER

Kod Code	Tip Type	Ebat Size	Filtrasyon Tipi Filtration Type	Debi Flow Rate m <sup>3</sup> /h	Ağırlık Weight kg
IR-MPE15	MAXI	1½"	Mesh - Elek	15	0,75
IR-MPE20	MAXI	2"	Mesh - Elek	25	1,20
IR-MPD15	MAXI	1½"	Disc - Disk	15	1,00
IR-MPD20	MAXI	2"	Disc - Disk	25	1,50



### PLASTİK FİLTRE İÇ TAKIMLARI PLASTIC FILTERS CARTRIDGE

Kod Code	Açıklama Description
IR-17001	Super
IR-17002	Normal

Disk Kartuş  
Disc Cartridge



Elek Kartuş  
Mesh Cartridge





## PLASTİK HİDROSİKLOKON PLASTIC HYDOCYCLONE

Kod Code	Tip Type	Ebat Size	Açıklama Description
IR-P2020	NORMAL	2"	2" PLASTIC HYDOCYCLONE
IR-P2025	NORMAL	2½"	2½" PLASTIC HYDOCYCLONE
IR-P203006	NORMAL	3"	3" PLASTIC HYDOCYCLONE DRAINAGE TANK 8 LT
IR-P203010	NORMAL	3"	3" PLASTIC HYDOCYCLONE DRAINAGE TANK 25 LT



## PLASTİK GÜBRE TANKI PLASTIC FERTILIZER TANK

Kod Code	Ebat Size	Açıklama Description
IR-P1100	100 Lt	NORMAL
IR-P1200	200 Lt	NORMAL
IR-P1100M	100 Lt	WITH MEMBRANE
IR-P1200M	200 Lt	WITH MEMBRANE



## PLASTİK KUM FİLTRESİ PLASTIC SAND MEDIA FILTER

Kod Code	Ebat Size	Açıklama Description
IR-P3020	2"	Plastic Sand media filter (24")
IR-P3025	2½"	Sand media filter (24")
IR-P3030	3"	Sand media filter (24")

Filtre Sistemleri  
Filter System

## BAĞLANTI TİPLERİ CONNECTION TYPES



2.5" VTV



2.5" VVT



2.5" TTT



3" VTV



3" VVT



3" TTT





## DİKEY METAL FİLTRELER VERTICAL METAL FILTERS

Kod Code	Ebat Size	Çap Diameter cm	Filtre Uzunluğu Filter Length	Kapasite Capacity m <sup>3</sup> /h
IR-17074	2"	16	25 cm	20
IR-17075	2"	22	25 cm	25
IR-17076	2 1/2"	22	35 cm	30
IR-17077	3"	22	40 cm	40
IR-17078	4"	22	50 cm	50



## YATAY METAL FİLTRELER HORIZONTAL METAL FILTERS

Kod Code	Ebat Size	Çap Diameter cm	Filtre Uzunluğu Filter Length	Kapasite Capacity m <sup>3</sup> /h
IR-17126	2"	22	25 cm	20
IR-17127	2 1/2"	22	35 cm	30
IR-17128	3"	22	40 cm	40
IR-17129	4"	22	50 cm	50



## METAL HİDROSİKLONLAR METAL HYDROCYCLONS

Kod Code	Ebat Size	Çap Diameter cm	Filtre Uzunluğu Filter Length	Kapasite Capacity m <sup>3</sup> /h
IR-17130	2"	22	220 cm	25
IR-17131	2 1/2"	28	280 cm	35
IR-17132	3"	28	280 cm	40
IR-17133	4"	28	280 cm	50
IR-17134	4"	32	320 cm	70
IR-17135	5"	38	380 cm	140
IR-17136	6"	45	450 cm	180

Filtre Sistemleri  
Filter System



## GLİSERİNLİ MANOMETRE PRESSURE GAUGE WITH GLYSERINE

Kod Code	Ebat Size	Paketleme-Koli Packaging-Box
IR-MAN-63-10	63/10 Bar - 1/4" Inlet Dia	100
IR-MAN-50-10	50/10 Bar - 1/4" Inlet Dia	100



## YATAY GÜBRE TANKLARI HORIZONTAL FERTILIZER TANKS

Kod Code	Çap Diameter cm	Kapasite Litre Capacity Liter
IR-17091	45	100 Lt.
IR-17092	60	200 Lt.
IR-17093	60	300 Lt.
IR-17094	60	400 Lt.



## DİKEY GÜBRE TANKLARI VERTICAL FERTILIZER TANKS

Kod Code	Çap Diameter cm	Kapasite Litre Capacity Liter
IR-17087	28	30 Lt.
IR-17088	38	60 Lt.
IR-17089	45	100 Lt.
IR-17090	60	200 Lt.

Filtre Sistemleri  
Filter System



## VENTURİ VENTURE TUBE

Kod Code	Ebat Size	Paketleme-Koli Packaging-Box
IR-VEN-3/4	¾"	1
IR-VEN-1	1"	1
IR-VEN-1 1/2	1½"	1
IR-VEN-2	2"	1

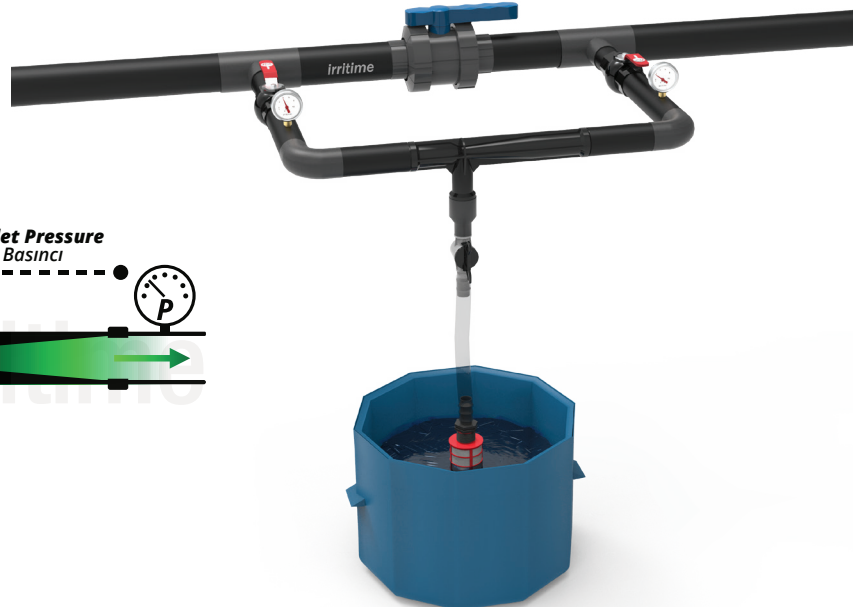

**Inlet Pressure**  
Giriş Basıncı



**Motive Flow**  
Akış Yönü



**Outlet Pressure**  
Çıkış Basıncı



**Suction Flow**  
Emme Akışı





## GRAVEL TANKLAR GRAVEL (MEDIA) FILTERS

Kod Code	Ebat Size	Çap Diameter inch	Kapasite Capacity m <sup>3</sup> /h
IR-17046	2"	18"	25
IR-17047	2 1/2"	24"	30
IR-17048	3"	24"	30
IR-17049	4"	24"	40
IR-17050	3"	36"	40
IR-17051	4"	36"	50



## TERS YIKAMALI GRAVELLER GRAVEL (MEDIA) FILTER BYPASS BACKFLUSH

Kod Code	Ebat Size	Çap Diameter inch	Kapasite Capacity m <sup>3</sup> /h
IR-17153	2"	18"	25
IR-17154	2 1/2"	24"	30
IR-17155	3"	24"	30
IR-17156	4"	24"	40
IR-17157	3"	36"	40
IR-17158	4"	36"	50

Filtre Sistemleri  
Filter System



## PLASTİK FİLTRELİ TERS YIKAMALI GRAVELLER GRAVELS (MEDIA) WITH PLASTIC FILTER BYPASS BACKFLUSH

Kod Code	Ebat Size	Çap Diameter inch	Kapasite Capacity m <sup>3</sup> /h
IR-17159	2"	18"	25
IR-17160	2 1/2"	24"	30
IR-17161	3"	24"	30
IR-17162	4"	24"	40
IR-17163	3"	36"	40
IR-17164	4"	36"	50



## TERS YIKAMALI ÇOKLU GRAVEL SİSTEMLER MULTIPLE GRAVELS (MEDIA) SYSTEM BACKFLUSH

Kod Code	Ebat Size	Filtre Adet Filter Piece	Kapasite Capacity m <sup>3</sup> /h
IR-17120	4"	2/3" (24")	70
IR-17121	5"	3/3" (24")	105
IR-17122	6"	4/3" (24")	140
IR-17123	5"	2/3" (36")	90
IR-17124	6"	3/3" (36")	135
IR-17125	6"	4/3" (36")	160

Filtre Sistemleri  
Filter System



## İKİZ PLASTİK FİLTRELİ SEPERATÖR SİSTEMLER SEPARATOR SYSTEM WITH DOUBLE PLASTIC FILTERS

Kod Code	Ebat Size	Çap Diameter cm	Filtre Cinsi Filter Type	Kapasite Capacity m <sup>3</sup> /h
IR-17143	2"	28	PLASTIC SINGLE FILTER	25
IR-17144	2 1/2"	28		35
IR-17145	3"	28		40
IR-17146	4"	28		50
IR-17147	3"	32	PLASTIC DOUBLE FILTER	50
IR-17148	4"	32		70



## İKİZ PLASTİK FİLTRELİ HİDROSİKLOK SİSTEMLER HYDROCYCLON SYSTEM WITH DOUBLE PLASTIC FILTER

Kod Code	Ebat Size	Çap Diameter cm	Filtre Cinsi Filter Type	Kapasite Capacity m <sup>3</sup> /h
IR-17150	3"	32	PLASTIC DOUBLE FILTER	50
IR-17152	4"	32		70



## PLASTİK FİLTRELİ HİDROSİKLOK SİSTEMLER HYDROCYCLON SYSTEM WITH PLASTIC FILTER

Kod Code	Ebat Size	Çap Diameter cm	Filtre Cinsi Filter Type	Kapasite Capacity m <sup>3</sup> /h
IR-17062	2"	28	PLASTIC SINGLE FILTER	25
IR-17063	2 1/2"	28		35
IR-17064	3"	28		40
IR-17065	4"	28		50

# **KABLİN EK PARÇALAR** **COUPLING FITTINGS**

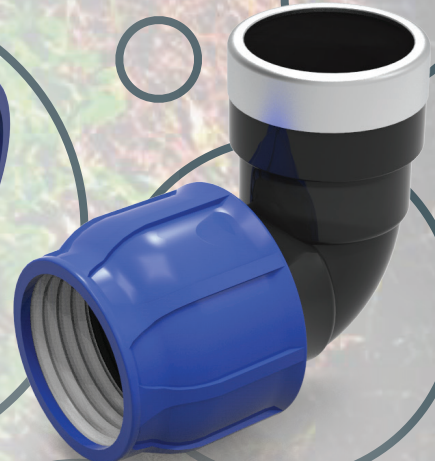
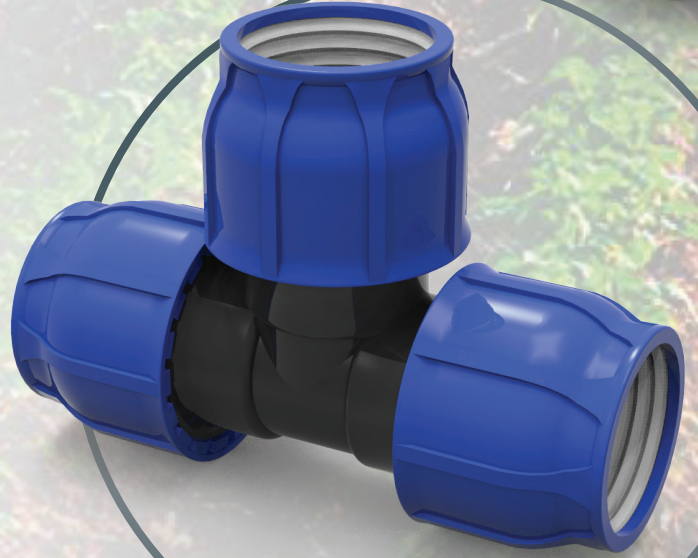

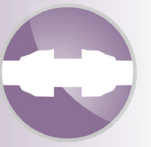

Kod Code	Erkek Kablin MALE ADAPTOR	Paketleme Packaging
IR-10001011	20 X ½"	50
IR-10001012	20 X ¾"	50
IR-10001021	25 X ½"	25
IR-10001022	25 X ¾"	25
IR-10001023	25 X 1"	25
IR-10001031	32 X ½"	25
IR-10001032	32 X ¾"	25
IR-10001033	32 X 1"	25
IR-10001034	32 X 1¼"	25
IR-10001043	40 X 1"	15
IR-10001044	40 X 1¼"	15
IR-10001045	40 X 1½"	15
IR-10001054	50 X 1¼"	10
IR-10001055	50 X 1½"	10
IR-10001056	50 X 2"	10
IR-10001065	63 X 1½"	6
IR-10001066	63 X 2"	6
IR-10001067	63 X 2½"	6
IR-10001076	75 X 2"	4
IR-10001077	75 X 2½"	4
IR-10001078	75 X 3"	4
IR-10001086	90 X 2½"	4
IR-10001087	90 X 2"	4
IR-10001088	90 X 3"	4
IR-10001089	90 X 4"	4
IR-10001095	110 X 2"	2
IR-10001096	110 X 2½"	2
IR-10001097	110 X 3"	2
IR-10001098	110 X 4"	2



Kod Code	Kablin Manşon COUPLING	Paketleme Packaging
IR-10002011	20 X 20	25
IR-10002022	25 X 25	25
IR-10002033	32 X 32	10
IR-10002044	40 X 40	10
IR-10002055	50 X 50	6
IR-10002066	63 X 63	5
IR-10002077	75 X 75	2
IR-10002088	90 X 90	2
IR-10002099	110 X 110	1



# PP EK PARÇALAR PP COMPRESSION FITTINGS



Kod Code	Dişi Kablin FEMALE ADAPTOR	Paketleme Packaging
IR-10008111	20 X ½"	50
IR-10008112	20 X ¾"	50
IR-10008121	25 X ½"	25
IR-10008122	25 X ¾"	25
IR-10008123	25 X 1"	25
IR-10008132	32 X ¾"	25
IR-10008133	32 X 1"	25
IR-10008134	32 X 1¼"	25
IR-10008143	40 X 1"	15
IR-10008144	40 X 1¼"	15
IR-10008145	40 X 1½"	15
IR-10008154	50 X 1¼"	10
IR-10008155	50 X 1½"	10
IR-10008156	50 X 2"	10
IR-10008165	63 X 1½"	6
IR-10008166	63 X 2"	6
IR-10008167	63 X 2½"	6
IR-10008176	75 X 2"	4
IR-10008177	75 X 2½"	4
IR-10008178	75 X 3"	4
IR-10008186	90 X 2"	4
IR-10008187	90 X 2½"	4
IR-10008188	90 X 3"	4
IR-10008189	90 X 4"	4
IR-10008195	110 X 2"	2
IR-10008196	110 X 2½"	2
IR-10008197	110 X 3"	2
IR-10008198	110 X 4"	2



Kod Code	Kablin Dirsek COUPLING ELBOW	Paketleme Packaging
IR-10004011	20 X 20	25
IR-10004022	25 X 25	15
IR-10004033	32 X 32	10
IR-10004044	40 X 40	5
IR-10004055	50 X 50	4
IR-10004066	63 X 63	4
IR-10004077	75 X 75	2
IR-10004088	90 X 90	1
IR-10004099	110 X 110	1

PP Ek Parçalar  
PP Compression Fittings



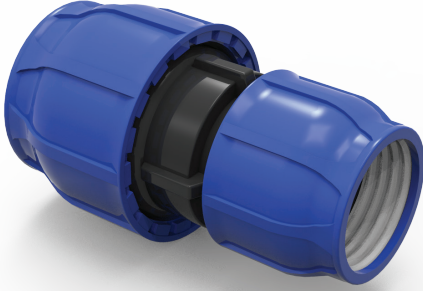

Kod Code	Kablin Redüksiyon COUPLING REDUCING	Paketleme Packaging
IR-10006021	25 x 20	25
IR-10006031	32 x 20	10
IR-10006032	32 x 25	10
IR-10006041	40 x 20	10
IR-10006042	40 x 25	10
IR-10006043	40 x 32	10
IR-10006052	50 x 25	6
IR-10006053	50 x 32	6
IR-10006054	50 x 40	6
IR-10006062	63 x 25	6
IR-10006063	63 x 32	6
IR-10006064	63 x 40	6
IR-10006065	63 x 50	6
IR-10006075	75 x 50	2
IR-10006076	75 x 63	2
IR-10006086	90 x 63	2
IR-10006087	90 x 75	2
IR-10006097	110 x 75	1
IR-10006098	110 x 90	1



Kod Code	Kablin Körtapa END CAP	Paketleme Packaging
IR-10007011	20	50
IR-10007022	25	25
IR-10007033	32	25
IR-10007044	40	15
IR-10007055	50	12
IR-10007066	63	6
IR-10007077	75	4
IR-10007088	90	4
IR-10007099	110	2



# PP EK PARÇALAR PP COMPRESSION FITTINGS



Kod Code	Kablin Manşon Te COUPLING TEE	Paketleme Packaging
IR-10002511	20 x 20 x 20	15
IR-10002522	25 x 25 x 25	10
IR-10002533	32 x 32 x 32	5
IR-10002544	40 x 40 x 40	5
IR-10002555	50 x 50 x 50	4
IR-10002566	63 x 63 x 63	3
IR-10002577	75 x 75 x 75	1
IR-10002588	90 x 90 x 90	1
IR-10002599	110 x 110 x 110	1

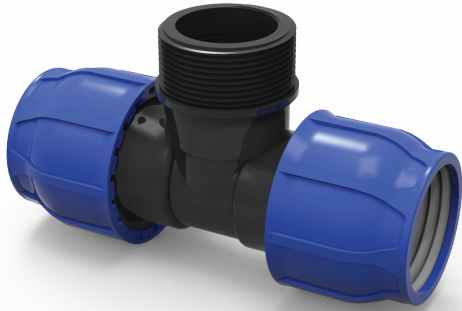

Kod Code	Kablin Erkek Te COUPLING MALE TEE	Paketleme Packaging
IR-10003011	20 x 1/2" x 20	15
IR-10003012	20 x 3/4" x 20	15
IR-10003021	25 x 1/2" x 25	10
IR-10003022	25 x 3/4" x 25	10
IR-10003023	25 x 1" x 25	10
IR-10003032	32 x 3/4" x 32	10
IR-10003033	32 x 1" x 32	10
IR-10003034	32 x 1 1/4" x 32	10
IR-10003043	40 x 1" x 40	5
IR-10003044	40 x 1 1/4" x 40	5
IR-10003045	40 x 1 1/2" x 40	5
IR-10003053	50 x 1" x 50	4
IR-10003054	50 x 1 1/4" x 50	4
IR-10003055	50 x 1 1/2" x 50	4
IR-10003056	50 x 2" x 50	4
IR-10003064	63 x 1 1/4" x 63	3
IR-10003065	63 x 1 1/2" x 63	3
IR-10003066	63 x 2" x 63	3
IR-10003067	63 x 2 1/2" x 63	3
IR-10003076	75 x 2" x 75	1
IR-10003077	75 x 2 1/2" x 75	1
IR-10003078	75 x 3" x 75	1
IR-10003086	90 x 2" x 90	1
IR-10003087	90 x 2 1/2" x 90	1
IR-10003088	90 x 3" x 90	1
IR-10003089	90 x 4" x 90	1
IR-10003096	110 x 2 1/2" x 110	1
IR-10003097	110 x 3" x 110	1
IR-10003098	110 x 4" x 110	1

PP EK Parçalar  
PP Compression Fittings

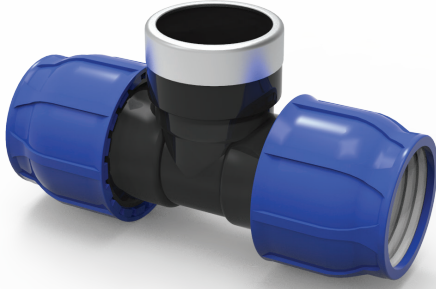

Kod Code	Kablin Dişi Te COUPLING FEMALE TEE	Paketleme Packaging
IR-10008311	20 x ½" x 20	15
IR-10008312	20 x ¾" x 20	15
IR-10008321	25 x ½" x 25	10
IR-10008322	25 x ¾" x 25	10
IR-10008323	25 x 1" x 25	10
IR-10008331	32 x ½" x 32	10
IR-10008332	32 x ¾" x 32	10
IR-10008333	32 x 1" x 32	10
IR-10008334	32 x 1¼" x 32	10
IR-10008342	40 x ¾" x 40	5
IR-10008343	40 x 1" x 40	5
IR-10008344	40 x 1¼" x 40	5
IR-10008345	40 x 1½" x 40	5
IR-10008352	50 x ¾" x 50	4
IR-10008353	50 x 1" x 50	4
IR-10008354	50 x 1¼" x 50	4
IR-10008355	50 x 1½" x 50	4
IR-10008356	50 x 2" x 50	4
IR-10008363	63 x 1" x 63	3
IR-10008364	63 x 1¼" x 63	3
IR-10008365	63 x 1½" x 63	3
IR-10008366	63 x 2" x 63	3
IR-10008367	63 x 2½" x 63	3
IR-10008376	75 x 2" x 75	1
IR-10008377	75 x 2½" x 75	1
IR-10008378	75 x 3" x 75	1
IR-10008387	90 x 2½" x 90	1
IR-10008388	90 x 3" x 90	1
IR-10008389	90 x 4" x 90	1
IR-10008396	110 x 2½" x 110	1
IR-10008397	110 x 3" x 110	1
IR-10008398	110 x 4" x 110	1



# PP EK PARÇALAR PP COMPRESSION FITTINGS



Kod Code	Kablin Redüksiyon Te COUPLING REDUCING TEE	Paketleme Packaging
IR-10005521	25 x 20 x 25	10
IR-10005531	32 x 20 x 32	5
IR-10005532	32 x 25 x 32	5
IR-10005542	40 x 25 x 40	5
IR-10005543	40 x 32 x 40	5
IR-10005552	50 x 25 x 50	4
IR-10005553	50 x 32 x 50	4
IR-10005554	50 x 40 x 50	4
IR-10005562	63 x 25 x 63	3
IR-10005563	63 x 32 x 63	3
IR-10005564	63 x 40 x 63	3
IR-10005565	63 x 50 x 63	3
IR-10005575	75 x 50 x 75	1
IR-10005576	75 x 63 x 75	1
IR-10005586	90 x 63 x 90	1
IR-10005587	90 x 75 x 90	1
IR-10005596	110 x 63 x 110	1
IR-10005597	110 x 75 x 110	1
IR-10005598	110 x 90 x 110	1

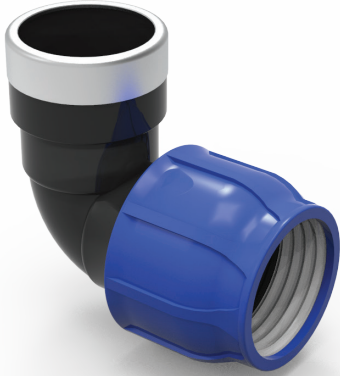

Kod Code	Kablin Dişi Dirsek COUPLING FEMALE ELBOW	Paketleme Packaging
IR-10008511	20 x ½"	600
IR-10008512	20 x ¾"	550
IR-10008521	25 x ½"	420
IR-10008522	25 x ¾"	360
IR-10008523	25 x 1"	330
IR-10008532	32 x ¾"	220
IR-10008533	32 x 1"	240
IR-10008534	32 x 1¼"	190
IR-10008543	40 x 1"	130
IR-10008544	40 x 1¼"	130
IR-10008545	40 x 1½"	110
IR-10008554	50 x 1¼"	88
IR-10008555	50 x 1½"	80
IR-10008556	50 x 2"	68
IR-10008565	63 x 1½"	44
IR-10008566	63 x 2"	48
IR-10008567	63 x 2½"	40
IR-10008576	75 x 2"	32
IR-10008577	75 x 2½"	30
IR-10008578	75 x 3"	28
IR-10008587	90 x 2½"	18
IR-10008588	90 x 3"	18
IR-10008589	90 x 4"	16
IR-10008597	110 x 3"	11
IR-10008598	110 x 4"	10

PP EK Parçalar  
PP Compression Fittings





Kod Code	Kablin Erkek Dirsek COUPLING MALE ELBOW	Paketleme Packaging
IR-10004511	20 x ½"	25
IR-10004512	20 x ¾"	25
IR-10004521	25 x ½"	15
IR-10004522	25 x ¾"	15
IR-10004523	25 x 1"	15
IR-10004532	32 x ¾"	10
IR-10004533	32 x 1"	10
IR-10004534	32 x 1¼"	10
IR-10004543	40 x 1"	5
IR-10004544	40 x 1¼"	5
IR-10004545	40 x 1½"	5
IR-10004554	50 x 1¼"	4
IR-10004555	50 x 1½"	4
IR-10004556	50 x 2"	4
IR-10004565	63 x 1½"	4
IR-10004566	63 x 2"	4
IR-10004567	63 x 2½"	4
IR-10004576	75 x 2"	2
IR-10004577	75 x 2½"	2
IR-10004578	75 x 3"	2
IR-10004587	90 x 2½"	1
IR-10004588	90 x 3"	1
IR-10004589	90 x 4"	1
IR-10004597	110 x 3"	1
IR-10004598	110 x 4"	1



Kod Code	Kablin Redüksiyon Dirsek REDUCING ELBOW	Paketleme Packaging
IR-10006521	25 x 20	15
IR-10006532	32 x 25	10
IR-10006543	40 x 32	5
IR-10006554	50 x 40	4
IR-10006565	63 x 50	4
IR-10006576	75 x 63	2
IR-10006587	90 x 75	1
IR-10006598	110 x 90	1



# PP EK PARÇALAR PP COMPRESSION FITTINGS



Kod Code	PRİZ KOLYE CLAMP SADDLE BOLTED	Paketleme Packaging
IR-100120201	25 x ½"	25
IR-100120301	32 x ½"	25
IR-100120302	32 x ¾"	25
IR-100120401	40 x ½"	25
IR-100120402	40 x ¾"	25
IR-100120501	50 x ½"	10
IR-100120502	50 x ¾"	10
IR-100120503	50 x 1"	10
IR-100120601	63 x ½"	10
IR-100120602	63 x ¾"	10
IR-100120603	63 x 1"	10
IR-100120604	63 x 1 ¼"	10
IR-100120605	63 x 1 ½"	10
IR-100120701	75 x ½"	5
IR-100120702	75 x ¾"	5
IR-100120703	75 x 1"	5
IR-100120704	75 x 1 ¼"	5
IR-100120705	75 x 1 ½"	5
IR-100120706	75 x 2"	5
IR-100120801	90 x ½"	5
IR-100120802	90 x ¾"	5
IR-100120803	90 x 1"	5
IR-100120804	90 x 1 ¼"	5
IR-100120805	90 x 1 ½"	5
IR-100120806	90 x 2"	5
IR-100120901	110 x ½"	5
IR-100120902	110 x ¾"	5
IR-100120903	110 x 1"	5
IR-100120904	110 x 1 ¼"	5
IR-100120905	110 x 1 ½"	5
IR-100120906	110 x 2"	5

PP Ek Parçalar  
PP Compression Fittings

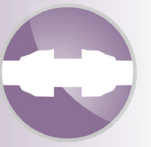

Kod Code	ÇİFT ÇIKIŞ PRİZ KOLYE DUBBLE CLAMP SADDLE (BOLTED)	Paketleme Packaging
IR-100140201	25 x ½" x ½"	25
IR-100140301	32 x ½" x ½"	25
IR-100140302	32 x ¾" x ¾"	25
IR-100140401	40 x ½" x ½"	25
IR-100140402	40 x ¾" x ¾"	25
IR-100140501	50 x ½" x ½"	10
IR-100140502	50 x ½" x ½"	10
IR-100140503	50 x 1" x 1"	10
IR-100140601	63 x ½" x ½"	10
IR-100140602	63 x ¾" x ¾"	10
IR-100140603	63 x 1" x 1"	10
IR-100140604	63 x 1 ¼" x 1 ¼"	10
IR-100140605	63 x 1 ½" x 1 ½"	10
IR-100140701	75 x ½" x ½"	5
IR-100140702	75 x ¾" x ¾"	5
IR-100140703	75 x 1" x 1"	5
IR-100140704	75 x 1 ¼" x 1 ¼"	5
IR-100140705	75 x 1 ½" x 1 ½"	5
IR-100140706	75 x 2" x 2"	5
IR-100140801	90 x ½" x ½"	5
IR-100140802	90 x ¾" x ¾"	5
IR-100140803	90 x 1" x 1"	5
IR-100140804	90 x 1 ¼" x 1 ¼"	5
IR-100140805	90 x 1 ½" x 1 ½"	5
IR-100140806	90 x 2" x 2"	5
IR-100140901	110 x ½" x ½"	5
IR-100140902	110 x ¾" x ¾"	5
IR-100140903	110 x 1" x 1"	5
IR-100140904	110 x 1 ¼" x 1 ¼"	5
IR-100140905	110 x 1 ½" x 1 ½"	5
IR-100140906	110 x 2" x 2"	5

# VANALAR VALVES

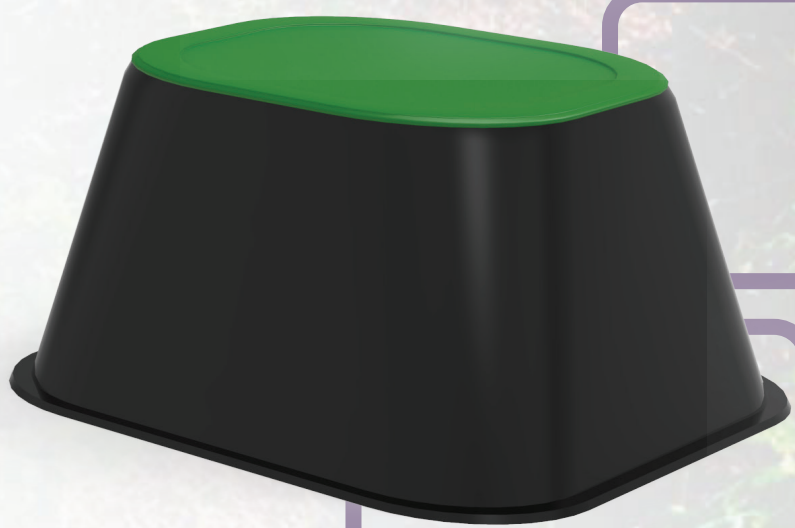
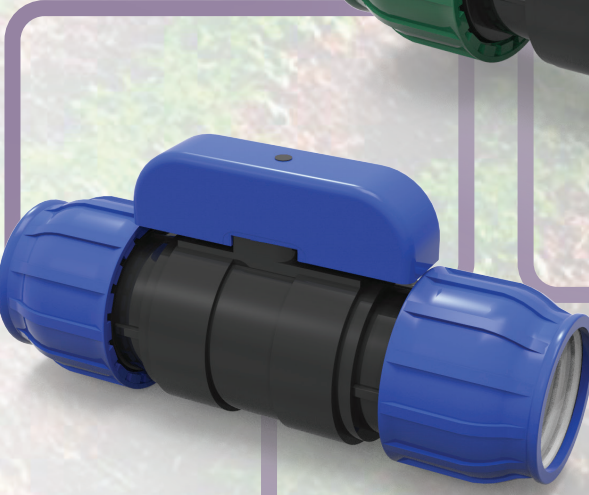
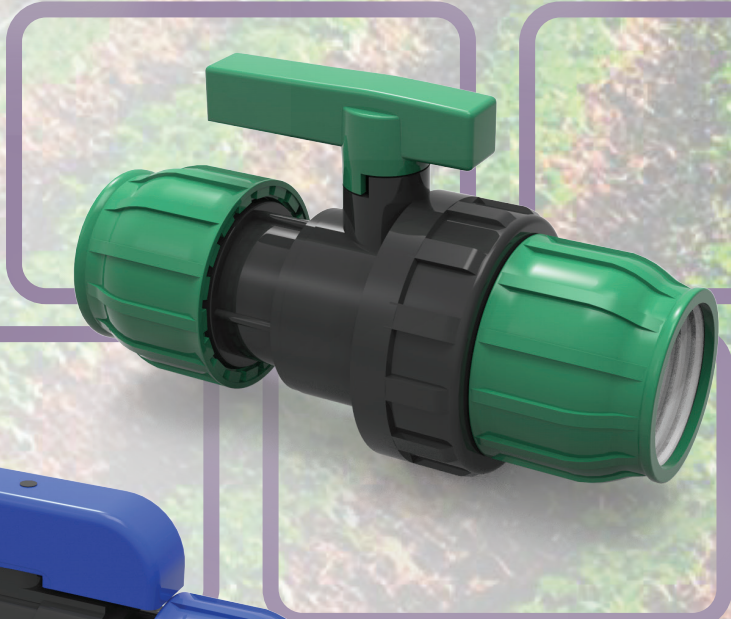



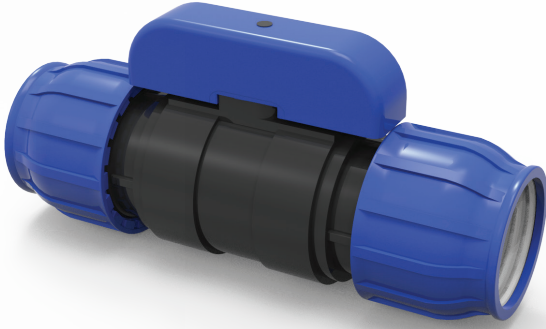

Kod Code	PP KABLİN KÜRESEL VANA PP COUPLING BALL VALVE	PN	Paketleme Packaging
IR-995711	20 X 20	10	10
IR-995722	25 X 25	10	6
IR-995733	32 X 32	10	5
IR-995744	40 X 40	10	5
IR-995755	50 X 50	10	5
IR-995766	63 X 63	10	2

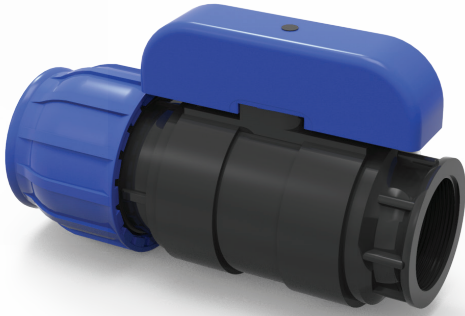

Kod Code	PP KABLİN DİŞİ KÜRESEL VANA PP COUPLING-FEMALE BALL VALVE	PN	Paketleme Packaging
IR-994711	20 X ½"	10	10
IR-994722	25 X ¾"	10	6
IR-994733	32 X 1"	10	5
IR-994744	40 X 1¼"	10	5
IR-994755	50 X 1½"	10	4
IR-994766	63 X 2"	10	2



Kod Code	PP DİŞİ-DİŞİ KÜRESEL VANA PP FEMALE-FEMALE BALL VALVE	PN	Paketleme Packaging
IR-993711	½"x½"	10	10
IR-993722	¾"x¾"	10	10
IR-993733	1" x 1"	10	10
IR-993744	1 ¼" x 1 ¼"	10	6
IR-993755	1 ½" x 1 ½"	10	6
IR-993766	2" x 2"	10	4
IR-993777	2 ½" x 2 ½"	6	2
IR-993788	3" x 3"	6	2
IR-993799	4" x 4"	6	2



# PP EK PARÇALAR PP COMPRESSION FITTINGS

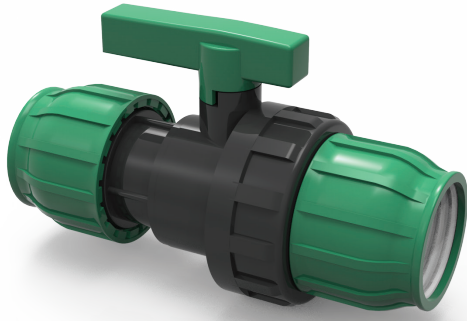

Kod Code	PP KABLİN KÜRESEL VANA PP COUPLING BALL VALVE	PN	Paketleme Packaging
IR-99544	40 x 40	10	4
IR-99555	50 x 50	10	2
IR-99566	63 x 63	10	2

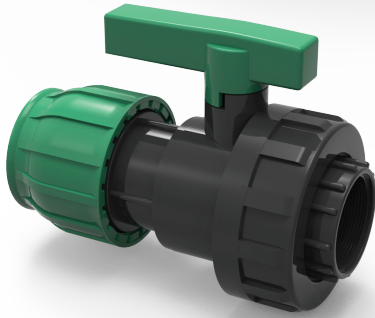

Kod Code	PP KABLİN-DİŞİ KÜRESEL VANA PP COUPLING-FEMALE BALL VALVE	PN	Paketleme Packaging
IR-99432	32 x ¾"	10	4
IR-99433	32 x 1"	10	4
IR-99443	40 x 1"	10	4
IR-99444	40 x 1 ¼"	10	4
IR-99454	50 x 1 ¼"	10	2
IR-99455	50 x 1 ½"	10	2
IR-99465	63 x 1 ½"	10	2
IR-99466	63 x 2 "	10	2



Kod Code	PP KABLİN ERKEK KÜRESEL VANA PP COUPLING-MALE BALL VALVE	PN	Paketleme Packaging
IR-99234	1" x 40	10	4
IR-99244	1 ¼" x 40	10	4
IR-99245	1 ¼" x 50	10	2
IR-99255	1 ½" x 50	10	2
IR-99256	1 ½" x 63	10	2
IR-99266	2" x 63	10	2



Kod Code	PP DİŞİ KÜRESEL VANA PP FEMALE BALL VALVE	PN	Paketleme Packaging
IR-99322	¾" x ¾"	10	4
IR-99332	1" x ¾"	10	4
IR-99333	1" x 1"	10	4
IR-99343	1 ¼" x 1"	10	4
IR-99344	1 ¼" x 1 ¼"	10	4
IR-99354	1 ½" x 1 ¼"	10	2
IR-99355	1 ½" x 1 ½"	10	2
IR-99365	2" x 1 ½"	10	2
IR-99366	2" x 2 "	10	2

PP Ek Parçalar  
PP Compression Fittings



Kod Code	PP ERKEK - DiŞİ KÜRESEL VANA PP MALE - FEMALE BALL VALVE	PN	Paketleme Packaging
IR-99122	¾" x ¾"	10	4
IR-99123	¾" x 1"	10	4
IR-99132	1" x ¾"	10	4
IR-99133	1" x 1"	10	4
IR-99134	1" x 1 ¼"	10	4
IR-99143	1 ¼" x 1"	10	4
IR-99144	1 ¼" x 1 ¼"	10	4
IR-99145	1 ¼" x 1 ½"	10	2
IR-99154	1 ½" x 1 ¼"	10	2
IR-99155	1 ½" x 1 ½"	10	2
IR-99156	1 ½" x 2"	10	2
IR-99165	2" x 1 ½"	10	2
IR-99166	2" x 2"	10	2

KEY



VALVE

Kod Code	Can Suyu Musluğu ve Anahtarı Quick Coupling Valve With Key	Paketleme Packaging
IR-6405-V	Musluk - Valve	100
IR-6405-K	Anahtar - Key	100



Kod Code	Vana Kutusu VALVE BOX	Paketleme Packaging
IR-73006	6"	1



Kod Code	Vana Kutusu VALVE BOX	Paketleme Packaging
IR-73010	10"	1

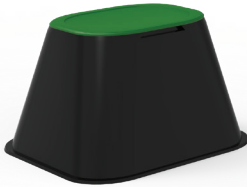

Kod Code	Vana Kutusu VALVE BOX	Paketleme Packaging
IR-73012	12"	1

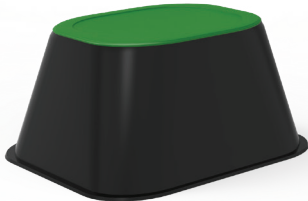

Kod Code	Vana Kutusu JUMBO VALVE BOX	Paketleme Packaging
IR-73014	14"	1



# PP EK PARÇALAR PP COMPRESSION FITTINGS



Kod Code	PVC KÜRESEL VANA PVC BALL VALVE	Paketleme Packaging
IR-PVC-1/2	½"	75
IR-PVC-3/4	¾"	65
IR-PVC-1	1"	50
IR-PVC-11/4	1¼"	45
IR-PVC-11/2	1½"	40
IR-PVC-2	2"	30
IR-PVC-21/2	2½"	25
IR-PVC-3	3"	15
IR-PVC-4	4"	8

Kod Code	ÇELİK KOLLU KÜRESEL VANA STEL ARM PVC BALL VALVE	Paketleme Packaging
IR-001	2"	100
IR-00125	2½"	100
IR-0013	3"	100
IR-0014	4"	100

Kod Code	ERKEK-DİŞİ KÜRESEL VANA MALE- FEMALE PVC BALL VALVE	Paketleme Packaging
IR-004	1" Erkek - Dişi Vana	100

PP EK Parçalar  
PP Compression Fittings

# YAĞMURLAMA SİSTEMLERİ SPRINKLER SYSTEMS





## SİYAH MİNİ SPRİNK BLACK MINI SPRINK

Kod Code	Ölçü Size	Meme Nozzle	Paketleme / Koli Packaging / box
IR-BMS-1/2	1/2"	2,5 x 3,5 mm	40
		2,0 x 3,0 mm	

Nozul Tipi Nozzle Type (mm)	Giriş Çapı Inlet Diameter (inch)	Basınç Pressure (bar)	Debi Flow Rate (l/h)	Sulama Çapı Irrigated Diameter (m)
2,5 x 3,5	1/2"	1,5	898	23
2,5 x 3,5	1/2"	2	1007	24
2,5 x 3,5	1/2"	2,5	1126	24
2,5 x 3,5	1/2"	3	1272	24,5
2,5 x 3,5	1/2"	3,5	1428	24,5
2 x 3	1/2"	1,5	656	22,5
2 x 3	1/2"	2	857	22,5
2 x 3	1/2"	2,5	898	22,5
2 x 3	1/2"	3	932	21,5
2 x 3	1/2"	3,5	1011	21,5



## TURUNCU MAKSİ SPRİNK ORANGE MAXI SPRINK

Kod Code	Ölçü Size	Meme Nozzle	Paketleme / Koli Packaging / box
IR-OMS-3/4	3/4"	2,3x3,8 mm	25
		4,5x5,0 mm	

Nozul Tipi Nozzle Type (mm)	Giriş Çapı Inlet Diameter (inch)	Basınç Pressure (bar)	Debi Flow Rate (l/h)	Sulama Çapı Irrigated Diameter (m)
4,5 x 5	3/4"	1,5	2140	24
4,5 x 5	3/4"	2	2360	25
4,5 x 5	3/4"	2,5	2690	25
4,5 x 5	3/4"	3	2890	26
4,5 x 5	3/4"	3,5	3140	27
2,3 x 3,8	3/4"	1,5	990	24,5
2,3 x 3,8	3/4"	2	1150	27
2,3 x 3,8	3/4"	2,5	1320	28
2,3 x 3,8	3/4"	3	1510	30
2,3 x 3,8	3/4"	3,5	1710	31



## GRİ MAKSİ SPRİNK GREY MAXI SPRINK

Kod Code	Ölçü Size	Meme Nozzle	Paketleme / Koli Packaging / box
IR-GMS-1	1"	2,3x3,8 mm	25
		4,5x5,0 mm	

Nozul Tipi Nozzle Type (mm)	Giriş Çapı Inlet Diameter (inch)	Basınç Pressure (bar)	Debi Flow Rate (l/h)	Sulama Çapı Irrigated Diameter (m)
4,5 x 5	1"	2	2380	25
4,5 x 5	1"	2,5	2710	26
4,5 x 5	1"	3	2920	28,2
4,5 x 5	1"	3,5	3006	30
2,3 x 3,8	1"	2	1160	26,5
2,3 x 3,8	1"	2,5	1340	27,5
2,3 x 3,8	1"	3	1520	28,8
2,3 x 3,8	1"	3,5	1730	29,8



## SİYAH AÇI AYARLI SPRİNK BLACK ADJUSTABLE SPRINK

Kod Code	Ölçü Size	Meme Nozzle	Paketleme / Koli Packaging / box
IR-BAS-3/4	3/4"	5 mm	25

Nozul Tipi Nozzle Type (mm)	Giriş Çapı Inlet Diameter (inch)	Basınç Pressure (bar)	Debi Flow Rate (l/h)	Sulama Çapı Irrigated Diameter (m)
5	3/4"	1,5	1380	24,8
5	3/4"	2	1520	25,3
5	3/4"	2,5	1730	26
5	3/4"	3	1860	26,4
5	3/4"	3,5	2020	27



## B/2 AÇILI YAĞMURLAMA BAŞLIĞI B/2 ADJUSTABLE RAINGUN



Tip - Type	B/2 AÇILI YAĞMURLAMA BAŞLIĞI
Çalışma Basıncı - Recommended Pressure	2 - 5 kg/cm <sup>2</sup>
Su Girişi - Inlet Diameter	1 1/2"
Ortalama Su Tüketimi - Water Requirement	5 - 15 m <sup>3</sup>
Atış Mesafesi (Yarıçap) - Water Throw (Radius)	15 - 30 m
Açı Aralığı - Angle Distance	30° - 360°
Nozul Çapları mm - Nozzle Types mm	8x6 - 10x6 - 12x6

Kod Code	NOZUL NOZZLE mm	Çalışma Basıncı Working Pressure (ATM - BAR)	Debi Flow Rate (m <sup>3</sup> /h)	Atış Mesafesi Water Throw (Yarıçap-Radius m)	Yağmurlama Aralığı Sprinkler Distance		
					mm/h	mxm	mxm
IR-B2ACI-86	8x6	2,0	4,90	19,50	11,34	8,51	6,81
		3,0	6,01	22,00	13,91	10,43	8,35
		4,0	6,91	24,00	16,00	12,00	9,60
		5,0	7,74	25,00	17,92	13,44	10,75
IR-B2ACI-106	10x6	2,0	6,77	21,50	15,67	11,75	9,40
		3,0	8,28	24,00	19,17	14,38	11,50
		4,0	9,68	26,50	22,18	16,63	13,31
		5,0	10,73	28,50	24,84	18,63	14,90
IR-B2ACI-126	12x6	2,0	9,07	23,00	21,00	15,75	12,60
		3,0	11,09	26,00	25,67	19,25	15,40
		4,0	12,82	28,50	28,68	22,26	17,80
		5,0	14,83	30,50	33,17	24,86	19,90



## B/2 AÇISIZ YAĞMURLAMA BAŞLIĞI B/2 FULL CIRCLE RAINGUN



Tip - Type	B/2 AÇISIZ YAĞMURLAMA BAŞLIĞI
Çalışma Basıncı - Recommended Pressure	2 - 5 kg/cm <sup>2</sup>
Su Girişi - Inlet Diameter	1 1/2"
Ortalama Su Tüketimi - Water Requirement	5 - 15 m <sup>3</sup>
Atış Mesafesi (Yarıçap) - Water Throw (Radius)	15 - 30 m
Açı Aralığı - Angle Distance	0° - 360°
Nozul Çapları mm - Nozzle Types mm	8x6 - 10x6 - 12x6

Kod Code	NOZUL NOZZLE mm	Çalışma Basıncı Working Pressure (ATM - BAR)	Debi Flow Rate (m <sup>3</sup> /h)	Atış Mesafesi Water Throw (Yarıçap-Radius m)	Yağmurlama Aralığı Sprinkler Distance		
					mm/h	mxm	
IR-B2ASIZ-86	8x6	2,0	4,90	19,50	11,34	8,51	6,81
		3,0	6,01	22,00	13,91	10,43	8,35
		4,0	6,91	24,00	16,00	12,00	9,60
		5,0	7,74	25,00	17,92	13,44	10,75
IR-B2ASIZ-106	10x6	2,0	6,77	21,50	15,67	11,75	9,40
		3,0	8,28	24,00	19,17	14,38	11,50
		4,0	9,68	26,50	22,18	16,63	13,31
		5,0	10,73	28,50	24,84	18,63	14,90
IR-B2ASIZ-126	12x6	2,0	9,07	23,00	21,00	15,75	12,60
		3,0	11,09	26,00	25,67	19,25	15,40
		4,0	12,82	28,50	28,68	22,26	17,80
		5,0	14,83	30,50	33,17	24,86	19,90



## ATILGAN AÇILI YAĞMURLAMA BAŞLIĞI ATILGAN ADJUSTABLE RAINGUN



Tip - Type	ATILGAN AÇILI YAĞMURLAMA BAŞLIĞI
Çalışma Basıncı - Recommended Pressure	2 - 5 kg/cm <sup>2</sup>
Su Girişi - Inlet Diameter	1 1/2"
Ortalama Su Tüketimi - Water Requirement	5 - 15 m <sup>3</sup>
Atış Mesafesi (Yarıçap) - Water Throw (Radius)	15 - 30 m
Açı Aralığı - Angle Distance	30° - 360°
Nozul Çapları mm - Nozzle Types mm	8x6 - 10x6 - 12x6

Kod Code	NOZUL NOZZLE mm	Çalışma Basıncı Working Pressure (ATM - BAR)	Debi Flow Rate (m <sup>3</sup> /h)	Atış Mesafesi Water Throw (Yarıçap-Radius m)	Yağmurlama Aralığı Sprinkler Distance		
					mm/h	mxm	
IR-ATILGAN-86	8x6	2,0	4,90	19,50	11,34	8,51	6,81
		3,0	6,01	22,00	13,91	10,43	8,35
		4,0	6,91	24,00	16,00	12,00	9,60
		5,0	7,74	25,00	17,92	13,44	10,75
IR-ATILGAN-106	10x6	2,0	6,77	21,50	15,67	11,75	9,40
		3,0	8,28	24,00	19,17	14,38	11,50
		4,0	9,68	26,50	22,18	16,63	13,31
		5,0	10,73	28,50	24,84	18,63	14,90
IR-ATILGAN-126	12x6	2,0	9,07	23,00	21,00	15,75	12,60
		3,0	11,09	26,00	25,67	19,25	15,40
		4,0	12,82	28,50	28,68	22,26	17,80
		5,0	14,83	30,50	33,17	24,86	19,90

## 1453 AÇILI PLASTİK BAŞLIĞI 1453 ADJUSTABLE RAINGUN



Tip - Type	ATILGAN AÇILI YAĞMURLAMA BAŞLIĞI
Çalışma Basıncı - Recommended Pressure	2 - 5 kg/cm <sup>2</sup>
Su Girişi - Inlet Diameter	1 1/2"
Ortalama Su Tüketimi - Water Requirement	5 - 25 m <sup>3</sup>
Atış Mesafesi (Yarıçap) - Water Throw (Radius)	20 - 29 m
Açı Aralığı - Angle Distance	30° - 360°
Nozul Çapları mm - Nozzle Types mm	Standart-10-12-14-16

Kod Code	NOZUL NOZZLE	Çalışma Basıncı Working Pressure (ATM - BAR)	Debi Flow Rate (m <sup>3</sup> /h)	Atış Mesafesi Water Throw (Yarıçap-Radius m)
IR-1453-STN	STANDART	2,0	5,1	16
		3,0	5,9	17,5
		4,0	7,2	19,5
		5,0	8,4	21
IR-1453-10	10 mm	2,0	7,8	18
		3,0	9,5	21
		4,0	11	23
		5,0	12,4	24,5
IR-1453-12	12 mm	2,0	10,1	19,5
		3,0	12,4	22
		4,0	14,3	25
		5,0	16,1	27,5
IR-1453-14	14 mm	2,0	12,9	20,5
		3,0	15,8	23,5
		4,0	18,3	26
		5,0	20,5	28,5
IR-1453-16	16 mm	2,0	16	21
		3,0	19,6	24
		4,0	22,7	26,5
		5,0	24,8	29



## ATILGAN JUNIOR AÇILI YAĞMURLAMA BAŞLIĞI ATILGAN JUNIOR ADJUSTABLE RAINGUN



Tip - Type	ATILGAN AÇILI YAĞMURLAMA BAŞLIĞI
Çalışma Basıncı - Recommended Pressure	2 - 5 kg/cm <sup>2</sup>
Su Girişi - Inlet Diameter	1"
Ortalama Su Tüketimi - Water Requirement	5 - 10 m <sup>3</sup>
Atış Mesafesi (Yarıçap) - Water Throw (Radius)	13 - 25 m
Açı Aralığı - Angle Distance	30° - 360°
Nozul Çapları mm - Nozzle Types mm	6x4 - 8x4 - 10x4

Kod Code	NOZUL NOZZLE	Çalışma Basıncı Working Pressure (ATM - BAR)	Debi Flow Rate (m <sup>3</sup> /h)	Sulanan Alan Irrigating Area (m <sup>2</sup> )
IR-ATJUN-64	6x4	2,0	11,40	408
		3,0	13,20	547
		4,0	16,00	803
		5,0	18,10	1028
IR-ATJUN-84	8x4	2,0	13,50	572
		3,0	16,40	844
		4,0	19,65	1212
		5,0	22,80	1632
IR-ATJUN-104	10x4	2,0	15,60	764
		3,0	18,68	1095
		4,0	21,40	1437
		5,0	24,80	1931

TS 6015 AÇILI PLASTİK SPRİNK  
TS 6015 ADJUSTABLE RAINGUN

Tip - Type	ATILGAN AÇILI YAĞMURLAMA BAŞLIĞI
Çalışma Basıncı - Recommended Pressure	2 - 4 kg/cm <sup>2</sup>
Su Girişi - Inlet Diameter	1"
Ortalama Su Tüketimi - Water Requirement	2 - 3,5 m <sup>3</sup>
Atış Mesafesi (Yarıçap) - Water Throw (Radius)	15 - 21 m
Açı Aralığı - Angle Distance	30 <sup>0</sup> - 360 <sup>0</sup>
Kod Code	IR-TS-6015

Çalışma Basıncı Working Pressure (ATM - BAR)	Debi Flow Rate (m <sup>3</sup> /h)	Atış Mesafesi Water Throw (Yarıçap-Radius m)
2,0	1,92	15
3,0	2,61	17,5
4,0	3,23	21



**DAMLA SULAMA BORUSU**  
**DRIP IRRIGATION PIPE**

**DAMLAMA EK PARÇALARI**  
**DRIP IRRIGATION FITTINGS**

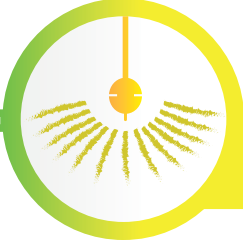

**MİKRO YAĞMURLAMA SİSTEMLERİ**  
**MICRO SPRINKLER**

**PE EK PARÇALAR**  
**PE COMPRESSION FITTINGS**

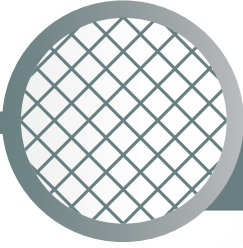
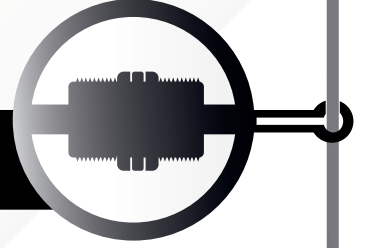

**FİLTRE SİSTEMLERİ**  
**FILTER SYSTEMS**

**PP EK PARÇALAR**  
**PP COMPRESSION FITTINGS**

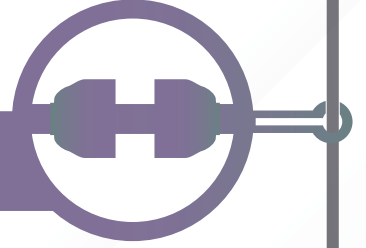

**YAĞMURLAMA SİSTEMLERİ**  
**SPRINKLER SYSTEMS**



**Fevzi Çakmak Mahallesi**  
**10762. Sokak No : 2D**  
**Karatay / KONYA**



**+90 (332) 502 27 95**



**info@irritime.com**



**/ www.irritime.com**

